

# Precision 5860 Tower

## Service Manual

## Notes, cautions, and warnings

 **NOTE:** A NOTE indicates important information that helps you make better use of your product.

 **CAUTION:** A CAUTION indicates either potential damage to hardware or loss of data and tells you how to avoid the problem.

 **WARNING:** A WARNING indicates a potential for property damage, personal injury, or death.

|   |           |
|---|-----------|
| <b>Chapter 1: Working inside your computer</b> .....                | <b>7</b>  |
| Safety instructions.....  | 7         |
| Before working inside your computer.....                            | 7         |
| Safety precautions.....   | 8         |
| Electrostatic discharge—ESD protection.....                         | 8         |
| ESD field service kit .....   | 9         |
| Transporting sensitive components.....                              | 10        |
| After working inside your computer.....                             | 10        |
| BitLocker.....  | 10        |
| <b>Chapter 2: Removing and installing components</b> .....          | <b>11</b> |
| Recommended tools.....  | 11        |
| Screw list.....   | 11        |
| Major components of Precision 5860 Tower.....                       | 12        |
| Side cover.....   | 14        |
| Removing the side cover.....  | 14        |
| Installing the side cover.....                                      | 15        |
| Front bezel .....   | 17        |
| Removing the front bezel.....                                       | 17        |
| Installing the front bezel.....                                     | 17        |
| I/O board.....  | 18        |
| Removing the front I/O bracket.....                                 | 18        |
| Installing the front I/O bracket.....                               | 19        |
| External storage flexbay (Hard drive).....                          | 20        |
| Removing the hard-drive assembly.....                               | 20        |
| Installing the hard-drive assembly.....                             | 20        |
| Removing a 3.5-inch hard-drive from a hard-drive assembly.....      | 21        |
| Installing a 3.5-inch hard-drive from hard-drive assembly.....      | 22        |
| Removing a 2.5-inch hard-disk drive from a hard-drive assembly..... | 23        |
| Installing a 2.5-inch hard-drive from a hard-drive assembly.....    | 24        |
| External storage flexbay (Solid-state drive).....                   | 25        |
| Removing the external solid-state drive assembly.....               | 25        |
| Removing the external M.2 2230 solid-state drive.....               | 26        |
| Installing the external M.2 2230 solid-state drive.....             | 27        |
| Removing the external M.2 2280 solid-state drive.....               | 28        |
| Installing the external M.2 2280 solid-state drive.....             | 29        |
| Installing the external solid-state drive assembly.....             | 30        |
| Slim optical-drive.....   | 31        |
| Removing the slim optical-drive.....                                | 31        |
| Installing the slim optical-drive.....                              | 32        |
| Air shroud.....   | 33        |
| Removing the air shroud.....  | 33        |
| Installing the air shroud.....                                      | 34        |
| PCIe holder.....  | 35        |

|   |    |
|---|----|
| Removing the PCIe holder.....                       | 35 |
| Installing the PCIe holder.....                     | 36 |
| Front fan.....                                      | 37 |
| Removing the front-fan assembly.....                | 37 |
| Removing front fan.....                             | 38 |
| Installing the front fan.....                       | 39 |
| Installing the front-fan assembly.....              | 39 |
| 3.5-inch hard-drive assembly.....                   | 40 |
| Removing the 3.5-inch hard-drive assembly.....      | 40 |
| Removing the 3.5-inch hard-drive bracket.....       | 41 |
| Installing the 3.5-inch hard-drive bracket.....     | 42 |
| Installing the 3.5-inch hard-drive assembly.....    | 43 |
| 2.5-inch hard-drive assembly.....                   | 45 |
| Removing the 2.5-inch hard-drive assembly.....      | 45 |
| Removing the 2.5-inch hard-disk drive bracket.....  | 46 |
| Installing the 2.5-inch hard-drive bracket.....     | 46 |
| Installing the 2.5-inch hard-drive assembly.....    | 47 |
| Hard-drive fan assembly.....                        | 48 |
| Removing the hard-drive fan assembly.....           | 48 |
| Installing the hard-drive fan assembly.....         | 49 |
| Bottom air-shroud.....                              | 51 |
| Removing the bottom air-shroud.....                 | 51 |
| Installing the bottom air-shroud.....               | 51 |
| Internal hard-drive cage.....                       | 52 |
| Removing the internal hard-drive cage.....          | 52 |
| Installing the internal hard-drive cage.....        | 53 |
| Rear fans.....                                      | 54 |
| Removing the rear-fan assembly.....                 | 54 |
| Removing rear fan.....                              | 55 |
| Installing the rear fan.....                        | 56 |
| Installing the rear-fan assembly.....               | 57 |
| Memory modules.....                                 | 58 |
| Removing the memory module.....                     | 58 |
| Installing the memory module.....                   | 59 |
| M.2 solid-state drive.....                          | 60 |
| Removing the M.2 2230 PCIe solid-state drive.....   | 60 |
| Installing the M.2 2230 PCIe solid-state drive..... | 61 |
| Removing the M.2 2280 PCIe solid-state drive.....   | 62 |
| Installing the M.2 2280 PCIe solid-state drive..... | 63 |
| Heat sink.....                                      | 64 |
| Removing the heat-sink assembly.....                | 64 |
| Installing the heat-sink assembly.....              | 65 |
| Processor.....                                      | 66 |
| Removing the processor.....                         | 66 |
| Installing the processor.....                       | 67 |
| Expansion card.....                                 | 68 |
| Removing the powered graphics-card.....             | 68 |
| Installing the powered graphics-card.....           | 69 |
| Removing the non-powered graphics card.....         | 71 |
| Installing the non-powered graphics card.....       | 71 |

|  |     |
|--|-----|
| Removing the UltraSpeed Duo card.....                        | 72  |
| Installing the UltraSpeed Duo card.....                      | 73  |
| Removing the UltraSpeed Quad card.....                       | 74  |
| Installing the UltraSpeed Quad card.....                     | 74  |
| Removing the Thunderbolt PCIe card.....                      | 75  |
| Installing the Thunderbolt PCIe card.....                    | 76  |
| Removing the wireless card.....                              | 77  |
| Installing the wireless card.....                            | 79  |
| Speaker.....   | 82  |
| Removing the speaker.....                                    | 82  |
| Installing the speaker.....                                  | 82  |
| Intrusion switch.....  | 83  |
| Removing the intrusion switch.....                           | 83  |
| Installing the intrusion switch.....                         | 84  |
| Voltage-regulator heat sink.....                             | 85  |
| Removing the voltage-regulator heat sink - Location 1.....   | 85  |
| Installing the voltage-regulator heat sink - Location 1..... | 86  |
| Removing the voltage-regulator heat sink - Location 2.....   | 86  |
| Installing the voltage-regulator heat sink - Location 2..... | 87  |
| Removing the voltage-regulator heat sink - Location 3.....   | 88  |
| Installing the voltage-regulator heat sink - Location 3..... | 89  |
| Power-supply unit.....                                       | 90  |
| Removing the power-supply unit.....                          | 90  |
| Installing the power-supply unit.....                        | 93  |
| System board.....  | 97  |
| System-board call outs.....                                  | 97  |
| Removing the system board.....                               | 98  |
| Installing the system board.....                             | 101 |
| Rail kit.....  | 104 |
| Removing the right rail-kit.....                             | 104 |
| Installing the right rail-kit.....                           | 107 |
| Removing the left rail-kit.....                              | 110 |
| Installing the left rail-kit.....                            | 113 |

**Chapter 3: Drivers and downloads.....117**

**Chapter 4: BIOS setup..... 118**

|  |     |
|--|-----|
| Entering BIOS setup program.....                       | 118 |
| Navigation keys.....                                   | 118 |
| One time boot menu.....                                | 118 |
| One Time Boot menu.....                                | 119 |
| System setup options.....                              | 119 |
| Updating the BIOS.....                                 | 130 |
| Updating the BIOS in Windows.....                      | 130 |
| Updating the BIOS in Linux and Ubuntu.....             | 131 |
| Updating the BIOS using the USB drive in Windows.....  | 131 |
| Updating the BIOS from the F12 One-Time boot menu..... | 131 |
| System and setup password.....                         | 132 |
| Assigning a system setup password.....                 | 132 |

|   |     |
|---|-----|
| Deleting or changing an existing system setup password..... | 133 |
| Clearing BIOS (System Setup) and System passwords.....      | 133 |

**Chapter 5: Troubleshooting..... 134**











|   |     |
|---|-----|
| Dell SupportAssist Pre-boot System Performance Check diagnostics..... | 134 |
| Running the SupportAssist Pre-Boot System Performance Check.....      | 134 |
| Power-Supply Unit Built-in Self-Test .....                            | 134 |
| System-diagnostic lights.....   | 134 |
| Recovering the operating system.....                                  | 136 |
| Real Time Clock—RTC reset.....  | 137 |
| Backup media and recovery options.....                                | 137 |
| Wi-Fi power cycle.....  | 137 |

**Chapter 6: Getting help and contacting Dell..... 139**

# Working inside your computer

## Safety instructions

Use the following safety guidelines to protect your computer from potential damage and to ensure your personal safety. Unless otherwise noted, each procedure included in this document assumes that you have read the safety information that shipped with your computer.

-  **WARNING:** Before working inside your computer, read the safety information that is shipped with your computer. For more safety best practices, see the Regulatory Compliance home page at [www.dell.com/regulatory\\_compliance](http://www.dell.com/regulatory_compliance).
-  **WARNING:** Disconnect your computer from all power sources before opening the computer cover or panels. After you finish working inside the computer, replace all covers, panels, and screws before connecting your computer to an electrical outlet.
-  **CAUTION:** To avoid damaging the computer, ensure that the work surface is flat, dry, and clean.
-  **CAUTION:** To avoid damaging the components and cards, handle them by their edges, and avoid touching the pins and the contacts.
-  **CAUTION:** You should only perform troubleshooting and repairs as authorized or directed by the Dell technical assistance team. Damage due to servicing that is not authorized by Dell is not covered by your warranty. See the safety instructions that is shipped with the product or at [www.dell.com/regulatory\\_compliance](http://www.dell.com/regulatory_compliance).
-  **CAUTION:** Before touching anything inside your computer, ground yourself by touching an unpainted metal surface, such as the metal at the back of the computer. While you work, periodically touch an unpainted metal surface to dissipate static electricity which could harm internal components.
-  **CAUTION:** When you disconnect a cable, pull it by its connector or its pull tab, not the cable itself. Some cables have connectors with locking tabs or thumbscrews that you must disengage before disconnecting the cable. When disconnecting cables, keep them evenly aligned to avoid bending the connector pins. When connecting cables, ensure that the ports and the connectors are correctly oriented and aligned.
-  **CAUTION:** Press and eject any installed card from the media-card reader.
-  **CAUTION:** Exercise caution when handling Lithium-ion batteries in laptops. Swollen batteries should not be used and should be replaced and disposed properly.
-  **NOTE:** The color of your computer and certain components may appear differently than shown in this document.

## Before working inside your computer

### About this task

-  **NOTE:** The images in this document may differ from your computer depending on the configuration you ordered.

### Steps

1. Save and close all open files and exit all open applications.
2. Shut down your computer. For Windows operating system, click **Start** >  **Power** > **Shut down**.

 **NOTE:** If you are using a different operating system, see the documentation of your operating system for shut-down instructions.

3. Disconnect your computer and all attached devices from their electrical outlets.
4. Disconnect all attached network devices and peripherals, such as keyboard, mouse, and monitor from your computer.

 **CAUTION:** To disconnect a network cable, first unplug the cable from your computer and then unplug the cable from the network device.

5. Remove any media card and optical disc from your computer, if applicable.

## Safety precautions

The safety precautions chapter details the primary steps to be taken before performing any disassembly instructions.

Observe the following safety precautions before you perform any installation or break/fix procedures involving disassembly or reassembly:

- Turn off the system and all attached peripherals.
- Disconnect the system and all attached peripherals from AC power.
- Disconnect all network cables, telephone, and telecommunications lines from the system.
- Use an ESD field service kit when working inside any to avoid electrostatic discharge (ESD) damage.
- After removing any system component, carefully place the removed component on an anti-static mat.
- Wear shoes with non-conductive rubber soles to reduce the chance of getting electrocuted.

## Standby power

Dell products with standby power must be unplugged before you open the case. Systems that incorporate standby power are essentially powered while turned off. The internal power enables the system to be remotely turned on (wake on LAN) and suspended into a sleep mode and has other advanced power management features.

Unplugging, pressing, and holding the power button for 15 seconds should discharge residual power in the system board.

## Bonding

Bonding is a method for connecting two or more grounding conductors to the same electrical potential. This is done through the use of a field service electrostatic discharge (ESD) kit. When connecting a bonding wire, ensure that it is connected to bare metal and never to a painted or non-metal surface. The wrist strap should be secure and in full contact with your skin, and ensure that you remove all jewelry such as watches, bracelets, or rings prior to bonding yourself and the equipment.

## Electrostatic discharge—ESD protection

ESD is a major concern when you handle electronic components, especially sensitive components such as expansion cards, processors, memory DIMMs, and system boards. Very slight charges can damage circuits in ways that may not be obvious, such as intermittent problems or a shortened product life span. As the industry pushes for lower power requirements and increased density, ESD protection is an increasing concern.

Due to the increased density of semiconductors used in recent Dell products, the sensitivity to static damage is now higher than in previous Dell products. For this reason, some previously approved methods of handling parts are no longer applicable.

Two recognized types of ESD damage are catastrophic and intermittent failures.

- **Catastrophic** – Catastrophic failures represent approximately 20 percent of ESD-related failures. The damage causes an immediate and complete loss of device functionality. An example of catastrophic failure is a memory DIMM that has received a static shock and immediately generates a "No POST/No Video" symptom with a beep code emitted for missing or nonfunctional memory.
- **Intermittent** – Intermittent failures represent approximately 80 percent of ESD-related failures. The high rate of intermittent failures means that most of the time when damage occurs, it is not immediately recognizable. The DIMM receives a static shock, but the tracing is merely weakened and does not immediately produce outward symptoms related to the damage. The weakened trace may take weeks or months to melt, and in the meantime may cause degradation of memory integrity, intermittent memory errors, etc.

The more difficult type of damage to recognize and troubleshoot is the intermittent (also called latent or "walking wounded") failure.

Perform the following steps to prevent ESD damage:

- Use a wired ESD wrist strap that is properly grounded. The use of wireless anti-static straps is no longer allowed; they do not provide adequate protection. Touching the chassis before handling parts does not ensure adequate ESD protection on parts with increased sensitivity to ESD damage.
- Handle all static-sensitive components in a static-safe area. If possible, use anti-static floor pads and workbench pads.
- When unpacking a static-sensitive component from its shipping carton, do not remove the component from the anti-static packing material until you are ready to install the component. Before unwrapping the anti-static packaging, ensure that you discharge static electricity from your body.
- Before transporting a static-sensitive component, place it in an anti-static container or packaging.

## ESD field service kit

The unmonitored Field Service kit is the most commonly used service kit. Each Field Service kit includes three main components: anti-static mat, wrist strap, and bonding wire.

### Components of an ESD field service kit

The components of an ESD field service kit are:

- **Anti-Static Mat** – The anti-static mat is dissipative and parts can be placed on it during service procedures. When using an anti-static mat, your wrist strap should be snug and the bonding wire should be connected to the mat and to any bare metal on the system being worked on. Once deployed properly, service parts can be removed from the ESD bag and placed directly on the mat. ESD-sensitive items are safe in your hand, on the ESD mat, in the system, or inside a bag.
- **Wrist Strap and Bonding Wire** – The wrist strap and bonding wire can be either directly connected between your wrist and bare metal on the hardware if the ESD mat is not required, or connected to the anti-static mat to protect hardware that is temporarily placed on the mat. The physical connection of the wrist strap and bonding wire between your skin, the ESD mat, and the hardware is known as bonding. Use only Field Service kits with a wrist strap, mat, and bonding wire. Never use wireless wrist straps. Always be aware that the internal wires of a wrist strap are prone to damage from normal wear and tear, and must be checked regularly with a wrist strap tester in order to avoid accidental ESD hardware damage. It is recommended to test the wrist strap and bonding wire at least once per week.
- **ESD Wrist Strap Tester** – The wires inside of an ESD strap are prone to damage over time. When using an unmonitored kit, it is a best practice to regularly test the strap prior to each service call, and at a minimum, test once per week. A wrist strap tester is the best method for doing this test. If you do not have your own wrist strap tester, check with your regional office to find out if they have one. To perform the test, plug the wrist-strap's bonding-wire into the tester while it is strapped to your wrist and push the button to test. A green LED is lit if the test is successful; a red LED is lit and an alarm sounds if the test fails.
- **Insulator Elements** – It is critical to keep ESD sensitive devices, such as plastic heat sink casings, away from internal parts that are insulators and often highly charged.
- **Working Environment** – Before deploying the ESD Field Service kit, assess the situation at the customer location. For example, deploying the kit for a server environment is different than for a desktop or portable environment. Servers are typically installed in a rack within a data center; desktops or portables are typically placed on office desks or cubicles. Always look for a large open flat work area that is free of clutter and large enough to deploy the ESD kit with additional space to accommodate the type of system that is being repaired. The workspace should also be free of insulators that can cause an ESD event. On the work area, insulators such as Styrofoam and other plastics should always be moved at least 12 inches or 30 centimeters away from sensitive parts before physically handling any hardware components
- **ESD Packaging** – All ESD-sensitive devices must be shipped and received in static-safe packaging. Metal, static-shielded bags are preferred. However, you should always return the damaged part using the same ESD bag and packaging that the new part arrived in. The ESD bag should be folded over and taped shut and all the same foam packing material should be used in the original box that the new part arrived in. ESD-sensitive devices should be removed from packaging only at an ESD-protected work surface, and parts should never be placed on top of the ESD bag because only the inside of the bag is shielded. Always place parts in your hand, on the ESD mat, in the system, or inside an anti-static bag.
- **Transporting Sensitive Components** – When transporting ESD sensitive components such as replacement parts or parts to be returned to Dell, it is critical to place these parts in anti-static bags for safe transport.

## ESD protection summary

It is recommended to use the traditional wired ESD grounding wrist strap and protective anti-static mat at all times when servicing Dell products. In addition, it is critical to keep sensitive parts separate from all insulator parts while performing service and that they use anti-static bags for transporting sensitive components.

## Transporting sensitive components

When transporting ESD sensitive components such as replacement parts or parts to be returned to Dell, it is critical to place these parts in anti-static bags for safe transport.

## Lifting equipment

Adhere to the following guidelines when lifting heavy weight equipment:

 **CAUTION: Do not lift greater than 50 pounds. Always obtain additional resources or use a mechanical lifting device.**

1. Get a firm balanced footing. Keep your feet apart for a stable base, and point your toes out.
2. Tighten stomach muscles. Abdominal muscles support your spine when you lift, offsetting the force of the load.
3. Lift with your legs, not your back.
4. Keep the load close. The closer it is to your spine, the less force it exerts on your back.
5. Keep your back upright, whether lifting or setting down the load. Do not add the weight of your body to the load. Avoid twisting your body and back.
6. Follow the same techniques in reverse to set the load down.

## After working inside your computer

### About this task

 **NOTE:** Leaving stray or loose screws inside your computer may severely damage your computer.

### Steps

1. Replace all screws and ensure that no stray screws remain inside your computer.
2. Connect any external devices, peripherals, or cables you removed before working on your computer.
3. Replace any media cards, discs, or any other parts that you removed before working on your computer.
4. Connect your computer and all attached devices to their electrical outlets.
5. Turn on your computer.

## BitLocker

 **CAUTION: If BitLocker is not suspended before updating the BIOS, the next time you reboot the system it will not recognize the BitLocker key. You will then be prompted to enter the recovery key to progress, and the system will ask for this on each reboot. If the recovery key is not known this can result in data loss or an unnecessary operating system reinstall. For more information about this subject, see Knowledge Article: [updating the BIOS on Dell systems with BitLocker enabled.](#)**

The installation of the following components triggers BitLocker:

- Hard disk drive or solid state drive
- System board

# Removing and installing components

**NOTE:** The images in this document may differ from your computer depending on the configuration you ordered.

## Recommended tools

The procedures in this document may require the following tools:

- Phillips screwdriver #0
- Phillips screwdriver #1
- Torx T20 screwdriver
- Plastic scribe





## Screw list

**NOTE:** When removing screws from a component, it is recommended to note the screw type, the quantity of screws, and then place them in a screw storage box. This is to ensure that the correct number of screws and correct screw type is restored when the component is replaced.









**NOTE:** Some computers have magnetic surfaces. Ensure that the screws are not left attached to such surfaces when replacing a component.

**NOTE:** Screw color may vary with the configuration ordered.

**Table 1. Screw list**

| Component               | Screw type        | Quantity | Screw image   |
|-------------------------|-------------------|----------|---|
| Front I/O bracket       | Captive           | 1        |  |
| Front fan               | M3x5              | 1        |  |
| Rear fan                | #6-32             | 2        |  |
| Solid-state drive1      | M2x3.5            | 1        |  |
| solid-state drive2      | M2x3.5            | 1        |  |
| Heat sink               | Captive: Torx T30 | 4        |  |
| Hard-drive fan assembly | M3x5              | 2        |  |

**Table 1. Screw list (continued)**

| <b>Component</b>                        | <b>Screw type</b> | <b>Quantity</b> | <b>Screw image</b>  |
|---|-------------------|-----------------|---|
| Bottom air-shroud                       | M3x5              | 2               |    |
| Internal hard-drive cage                | #6-32             | 5               |    |
| Solid-state drive heatsink              | Captive           | 4               |    |
| Intrusion switch                        | M3                | 1               |    |
| Solid-state drive heatsink              | Captive           | 4               |    |
| Power-supply unit                       | #6-32             | 6               |    |
| Voltage-Regulator heatsink - Location 2 | Captive           | 2               |    |
| System board                            | #6-32             | 11              |  |

## Major components of Precision 5860 Tower

The following image shows the major components of Precision 5860 Tower.

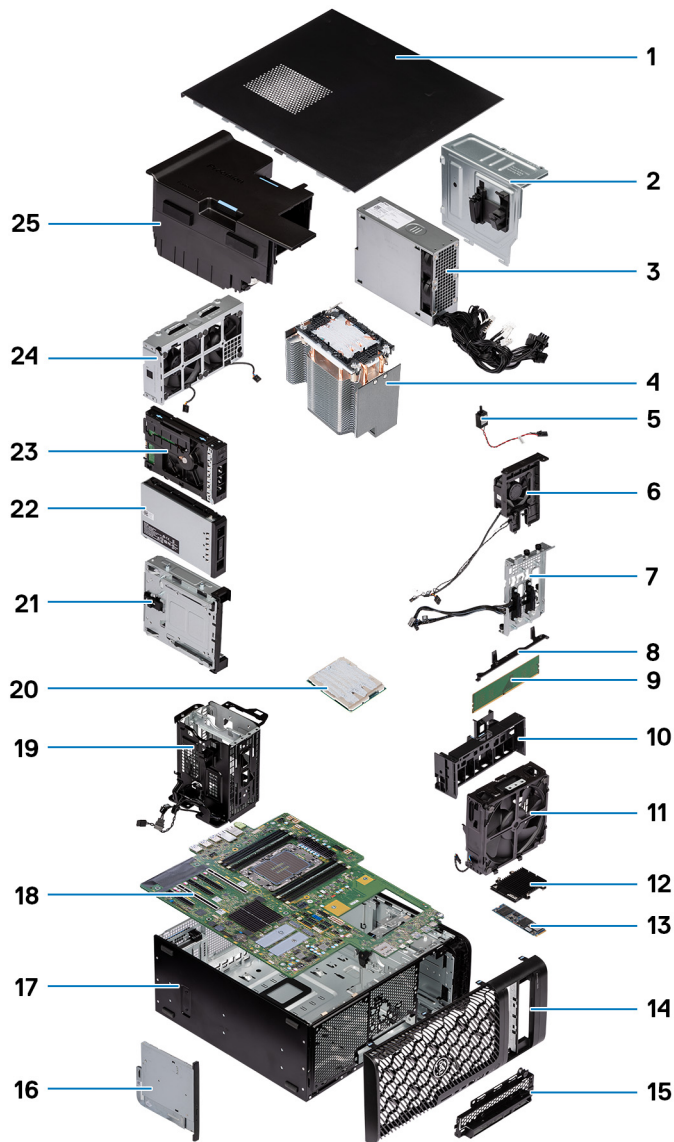

- |                                  |   |
|----------------------------------|---|
| 1. Side cover                    | 2. Power-supply cover                       |
| 3. Power-supply unit             | 4. Heat sink                                |
| 5. Intrusion switch              | 6. Hard-drive fan assembly                  |
| 7. Storage bay connectors        | 8. System-board supporting bracket          |
| 9. Memory module                 | 10. PCIe holder                             |
| 11. Front-fan assembly           | 12. Solid-state drive heat-sink             |
| 13. M.2 Solid-state drive        | 14. Front bezel                             |
| 15. Front I/O bracket            | 16. Slim optical-drive                      |
| 17. Chassis                      | 18. System board                            |
| 19. Internal hard-drive cage     | 20. Processor                               |
| 21. Optical-drive bay            | 22. M.2 external solid-state drive assembly |
| 23. External hard-drive assembly | 24. Rear-fan assembly                       |
| 25. Air shroud                   |   |

**i NOTE:** Dell provides a list of components and their part numbers for the original system configuration purchased. These parts are available according to warranty coverages purchased by the customer. Contact your Dell sales representative for purchase options.

# Side cover

## Removing the side cover

### Prerequisites

1. Follow the procedure in [Before working inside your computer](#).

 **NOTE:** Ensure that you remove the security cable from the security-cable slot (if applicable).

### About this task

The following images indicate the location of the side cover and provide a visual representation of the removal procedure.

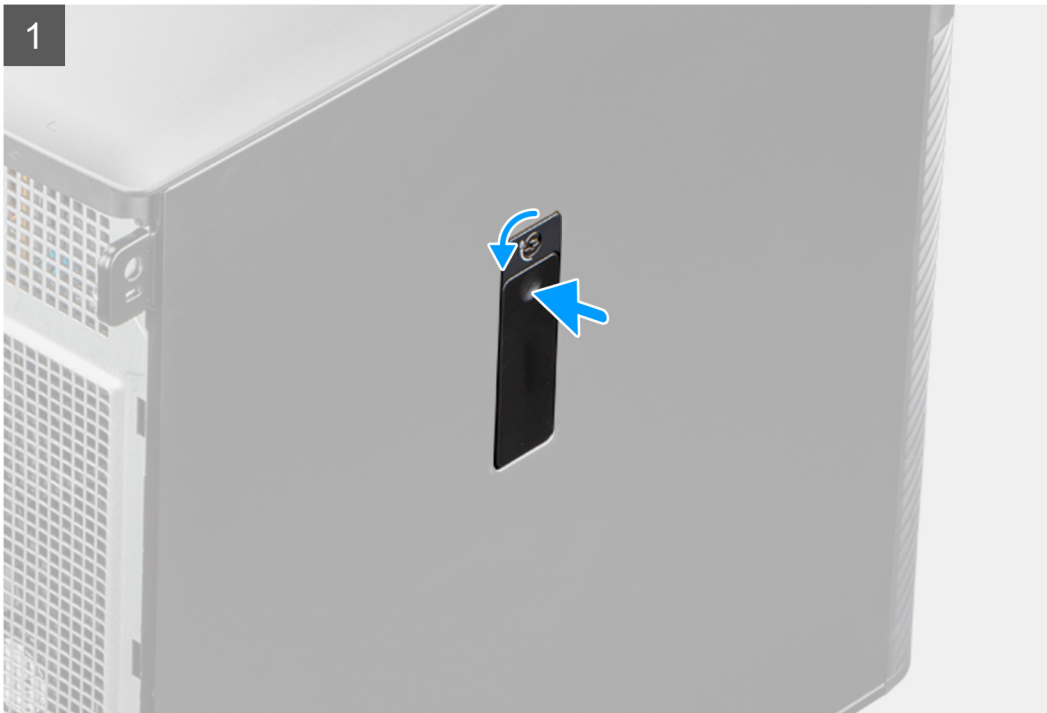

### Steps

1. Insert the side-cover key and turn the key counter-clockwise to unlock the side cover.
2. Push the latch and release the side cover from the computer.
3. Open the side cover at an angle and lift the cover away from the chassis.

## Installing the side cover

### Prerequisites

If you are replacing a component, remove the existing component before performing the installation procedure.

### About this task

The following images indicate the location of the side cover and provide a visual representation of the installation procedure.



### Steps

1. Align the tabs on the side cover with the slots on the chassis.
2. Press the side cover back towards the side of the computer to secure it.  
 **NOTE:** The release latch automatically locks the side cover to the computer.
3. Insert the side-cover key into the key slot and turn it clockwise to lock the side cover.

### Next steps

1. Follow the procedure in [After working inside your computer](#).

## Front bezel

### Removing the front bezel

#### Prerequisites

1. Follow the procedure in [Before working inside your computer](#).
2. Remove the [side cover](#).

#### About this task

The following images indicate the location of the front bezel and provide a visual representation of the removal procedure.

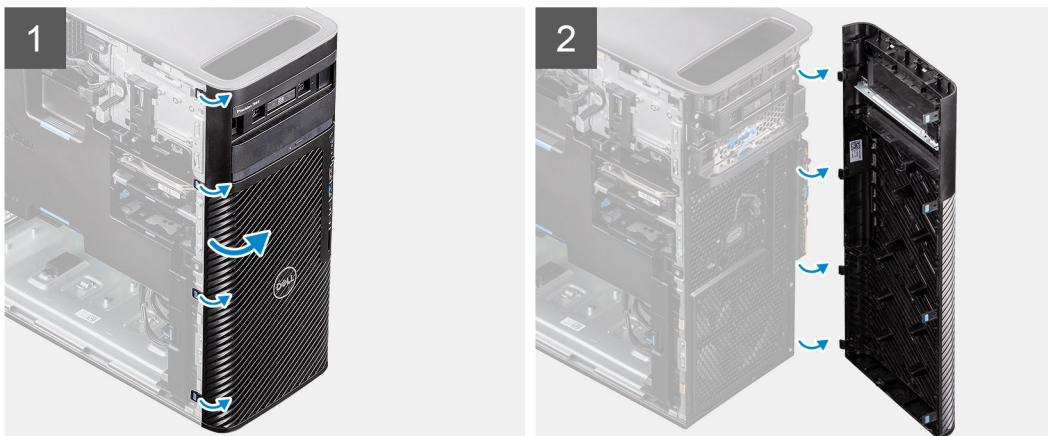

#### Steps

1. Pry the retention tabs to release the front bezel from the computer.
2. Slightly pull the front bezel and gently rotate to release the other tabs on the bezel from the slots in the chassis.
3. Remove the front bezel from the computer.

### Installing the front bezel

#### Prerequisites

If you are replacing a component, remove the existing component before performing the installation procedure.

#### About this task

The following images indicate the location of the front bezel and provide a visual representation of the installation procedure.

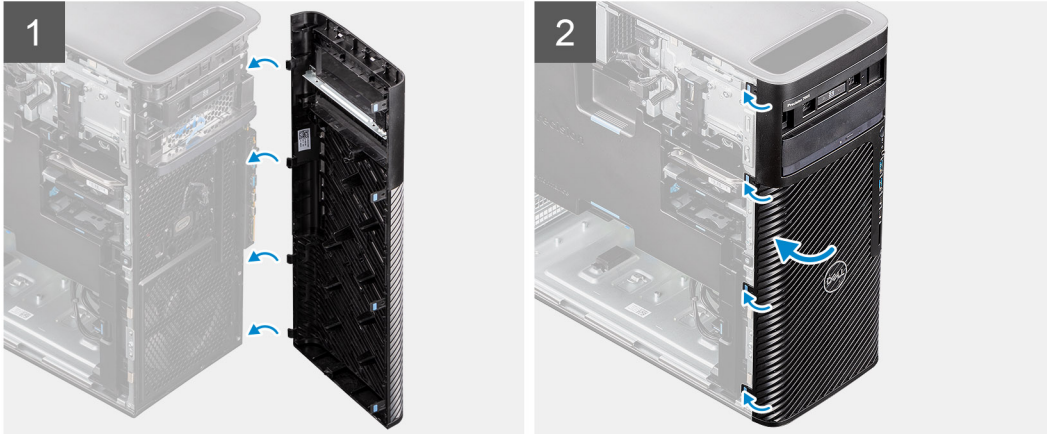
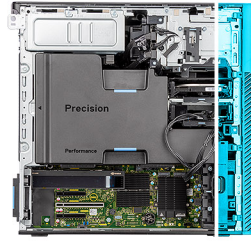

### Steps

1. Position the front bezel to align the tabs on the bezel with the slots on the chassis.
2. Press the bezel until the tabs clicks into place.

### Next steps

1. Install the [side cover](#).
2. Follow the procedure in [After working inside your computer](#).

## I/O board

### Removing the front I/O bracket

#### Prerequisites

1. Follow the procedure in [Before working inside your computer](#).
2. Remove the [side cover](#).
3. Remove the [front bezel](#).

#### About this task

The following images indicate the location of the front I/O bracket and provide a visual representation of the removal procedure.

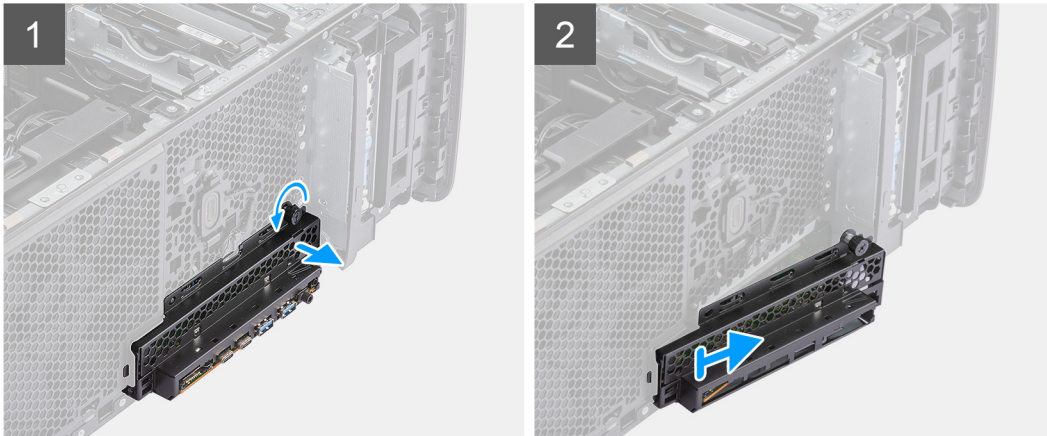

### Steps

1. Loosen the thumb screw on the front I/O bracket and unscrew it until the front I/O bracket is free to move.
2. Move the top end of the front I/O bracket at an angle to free it from its slot on the chassis.
3. Remove the front I/O bracket from the computer.

## Installing the front I/O bracket

### Prerequisites

If you are replacing a component, remove the existing component before performing the installation procedure.

### About this task

The following images indicate the location of the front I/O bracket and provide a visual representation of the installation procedure.

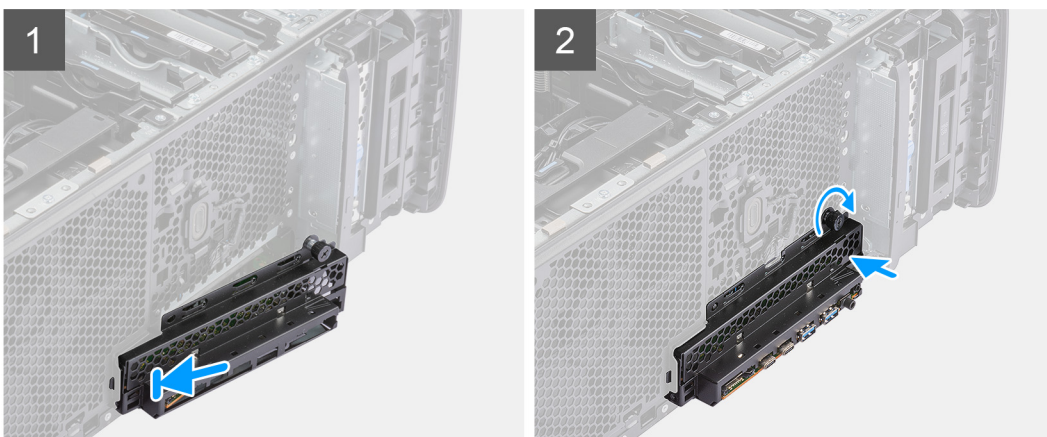

### Steps

1. Position the front I/O bracket to align the tabs on the bracket with the slots on the chassis.
2. Push in and tighten the thumb screw to secure the front I/O bracket to the chassis.

### Next steps

1. Install the [front bezel](#).
2. Install the [side cover](#).
3. Follow the procedure in [After working inside your computer](#).

# External storage flexbay (Hard drive)

## Removing the hard-drive assembly

### Prerequisites

1. Follow the procedure in [Before working inside your computer](#).

### About this task

The following images indicate the location of the hard-drive assembly and provide a visual representation of the removal procedure.



### Steps

1. Push the release button on the external-flexbay bracket to open the release latch.
2. Hold the release latch and slide the hard-drive assembly out of the external flexbay slot.

## Installing the hard-drive assembly

### Prerequisites

If you are replacing a component, remove the existing component before performing the installation procedure.

### About this task

The following images indicate the location of the hard-drive assembly and provide a visual representation of the installation procedure.



### Steps

1. Slide and insert the hard-drive assembly into the external flexbay slot.
2. Close the release latch to secure the hard-drive assembly in place.

### Next steps

1. Follow the procedure in [After working inside your computer](#).

## Removing a 3.5-inch hard-drive from a hard-drive assembly

### Prerequisites

1. Follow the procedure in [Before working inside your computer](#).
2. Remove the [hard-drive assembly](#)

### About this task

The following images indicate the location of a 3.5-inch hard-drive in a hard-drive assembly and provide a visual representation of the removal procedure.

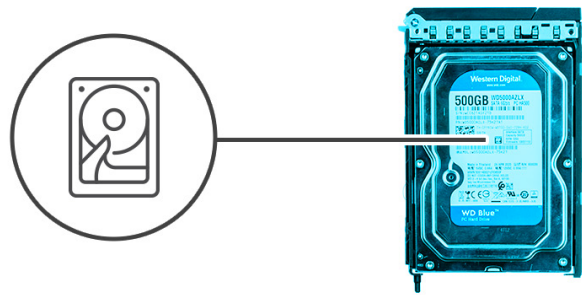

### Steps

1. Pry the sides of the external hard-drive bracket to release the pins on the bracket from the slots on the hard drive.
2. Lift and remove the hard drive off the external hard-drive bracket.

## Installing a 3.5-inch hard-drive from hard-drive assembly

### Prerequisites

If you are replacing a component, remove the existing component before performing the installation procedure.

### About this task

The following images indicate the location of a 3.5-inch hard-drive in a hard-drive assembly and provide a visual representation of the installation procedure.



### Steps

1. Place the hard drive into the external hard-drive bracket and align the pins on the bracket with the slots on the hard drive.
2. Snap the hard-drive into the external hard-drive bracket.

### Next steps

1. Install the [hard-drive assembly](#).
2. Follow the procedure in [After working inside your computer](#).

## Removing a 2.5-inch hard-disk drive from a hard-drive assembly

### Prerequisites

1. Follow the procedure in [Before working inside your computer](#).
2. Remove the [hard-drive assembly](#)

### About this task

The following images indicate the location of a 2.5-inch hard-drive in a hard-drive assembly and provide a visual representation of the removal procedure.

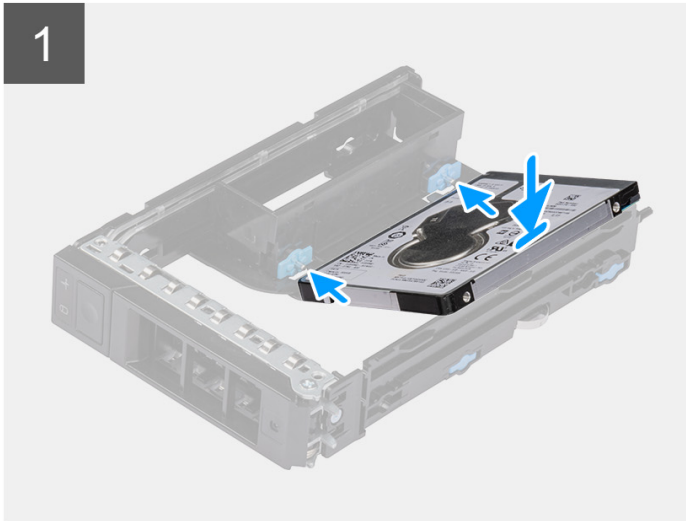
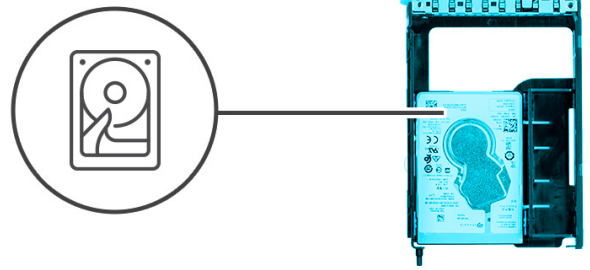

### Steps

1. Pry the sides of the external hard-drive bracket to release the pins on the bracket from the slots on the hard drive.
2. Lift and remove the hard drive off the external hard-drive bracket.

## Installing a 2.5-inch hard-drive from a hard-drive assembly

### Prerequisites

If you are replacing a component, remove the existing component before performing the installation procedure.

### About this task

The following images indicate the location of a 2.5-inch hard-drive in a hard-drive assembly and provide a visual representation of the installation procedure.

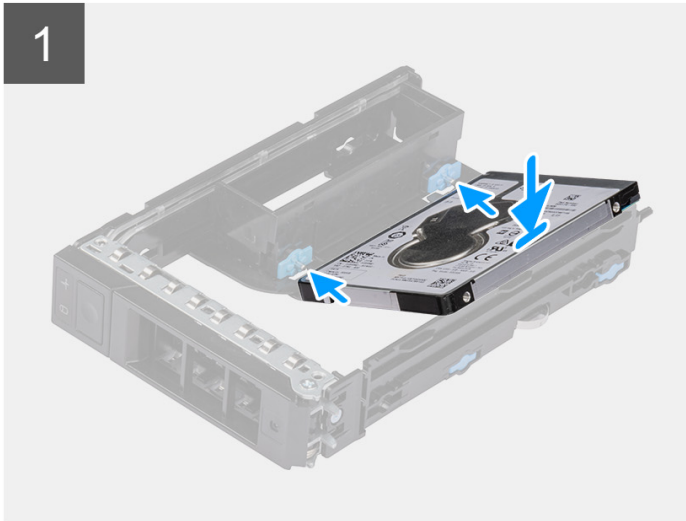
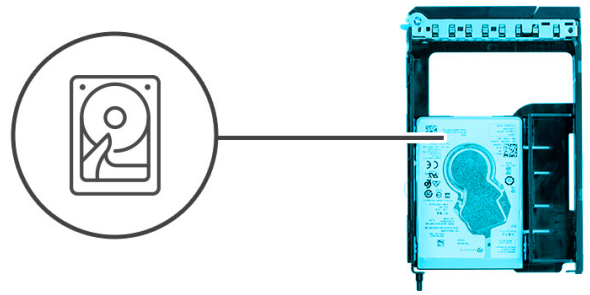

### Steps

1.  **NOTE:** 2.5 inch hard-drives are to be installed in hard-drive assemblies with an adapter installed to fit 2.5 inch hard-drives.

Place the hard drive into the external hard-drive bracket and align the pins on the bracket with the slots on the hard drive.

2. Snap the hard-drive into the external hard-drive bracket.

### Next steps

1. Install the [hard-drive assembly](#).
2. Follow the procedure in [After working inside your computer](#).

## External storage flexbay (Solid-state drive)

### Removing the external solid-state drive assembly

#### Prerequisites

1. Follow the procedure in [Before working inside your computer](#).

#### About this task

The following images indicate the location of the external solid-state drive assembly and provide a visual representation of the removal procedure.



### Steps

1. Push the release button on the external-flexbay bracket to open the release latch.
2. Hold the release latch and slide the solid-state drive assembly out of the external flexbay slot.

## Removing the external M.2 2230 solid-state drive

### Prerequisites

1. Follow the procedure in [Before working inside your computer](#).

### About this task

The following images indicate the location of the external M.2 2230 solid-state drive and provide a visual representation of the removal procedure.

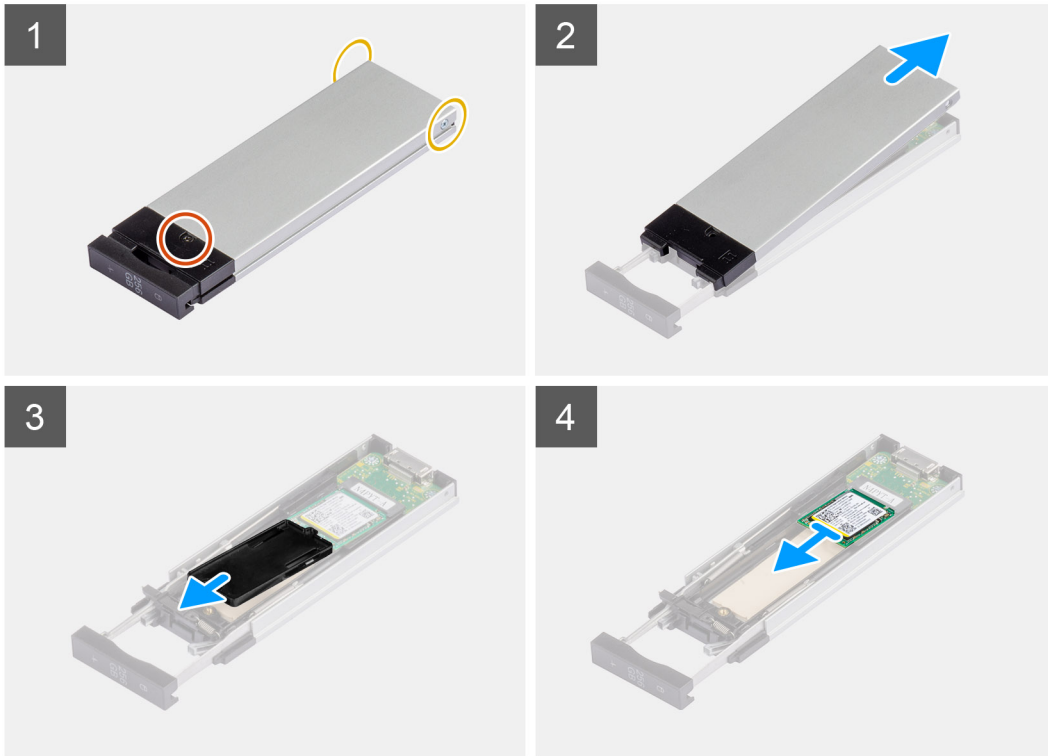

### Steps

1. Remove the single (M3x6) screw and the two (M3x3) screws from the solid-state drive assembly.
2. Lift and remove the cover from the solid-state drive assembly.
3. Slide and remove the solid-state drive holder from the solid-state drive assembly.
4. Slide and remove the solid-state drive from the solid-state drive assembly.

## Installing the external M.2 2230 solid-state drive

### Prerequisites

If you are replacing a component, remove the existing component before performing the installation procedure.

### About this task

The following images indicate the location of the external M.2 2230 solid-state drive and provide a visual representation of the installation procedure.

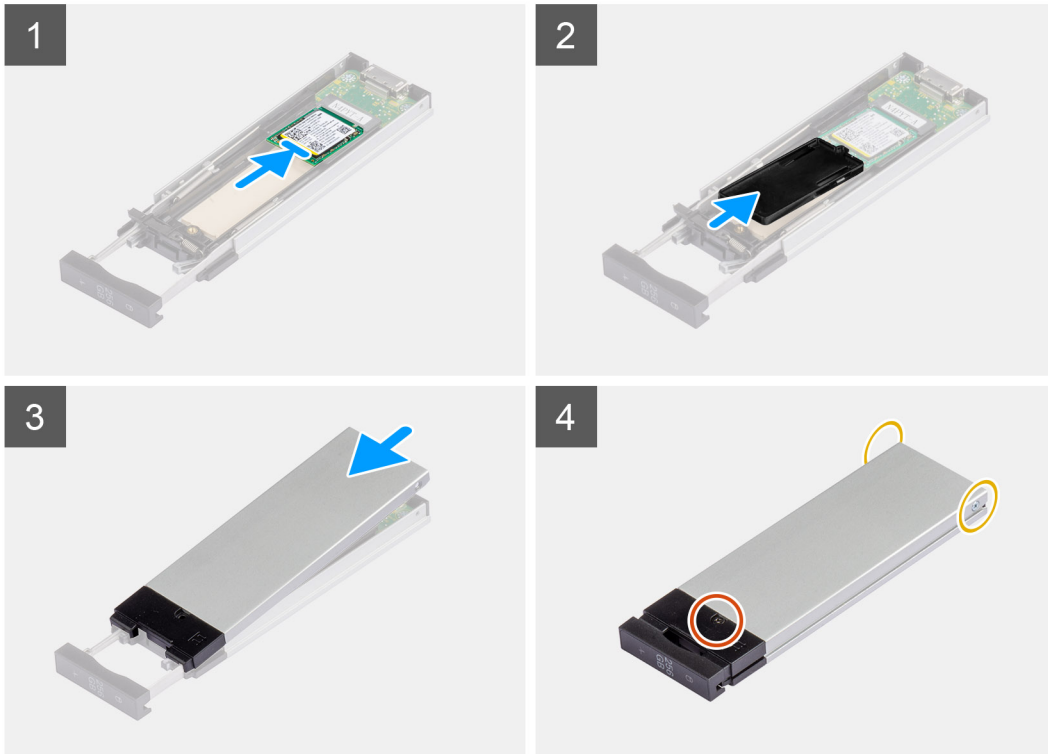

### Steps

1. Align the notch on the solid-state drive with the tab on the solid-state drive connector.
2. Insert the solid-state drive at a 45-degree angle into the slot on the solid-state drive assembly.
3. Align and place the solid-state drive bracket onto the solid-state drive assembly.
4. Place the cover over the solid-state drive assembly.
5. Install the single (M3x6) screw and the two (M3x3) screws to secure the cover to the solid-state drive assembly.

### Next steps

1. Follow the procedure in [After working inside your computer](#).

## Removing the external M.2 2280 solid-state drive

### Prerequisites

1. Follow the procedure in [Before working inside your computer](#).

### About this task

The following images indicate the location of the external M.2 2280 solid-state drive and provide a visual representation of the removal procedure.

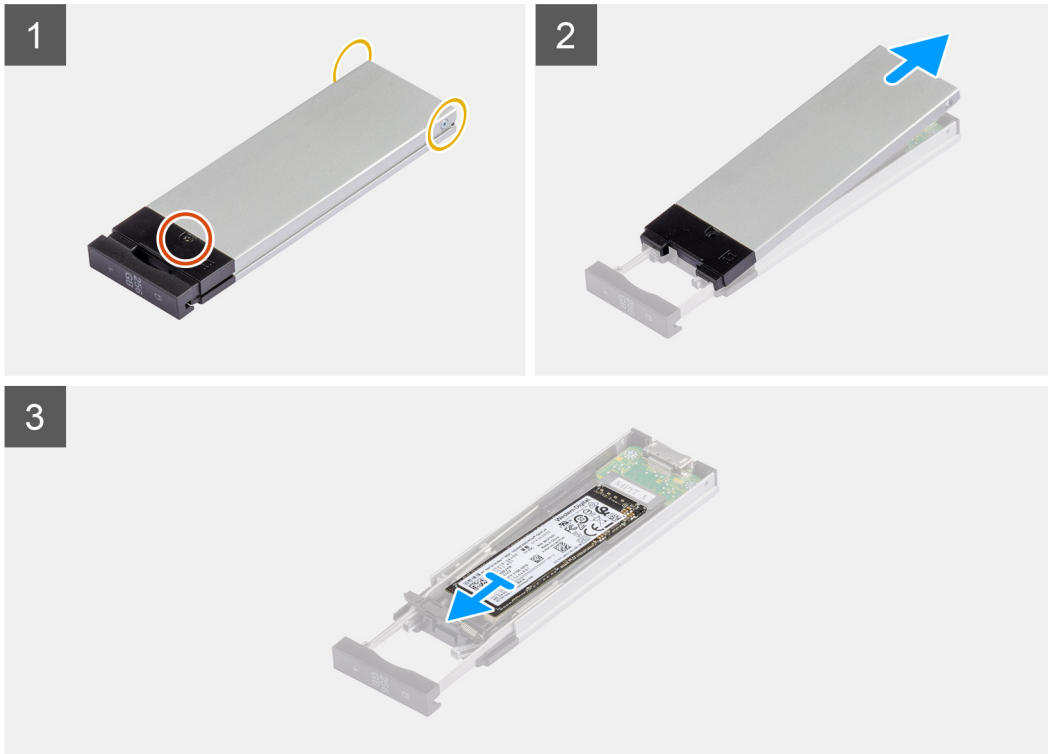

### Steps

1. Remove the single (M3x6) screw and the two (M3x3) screws from the solid-state drive assembly.
2. Lift and remove the cover from the solid-state drive assembly.
3. Slide and remove the solid-state drive from the solid-state drive assembly.

## Installing the external M.2 2280 solid-state drive

### Prerequisites

If you are replacing a component, remove the existing component before performing the installation procedure.

### About this task

The following images indicate the location of the external M.2 2280 solid-state drive and provide a visual representation of the installation procedure.



1x  
M3x6



2x  
M3x3

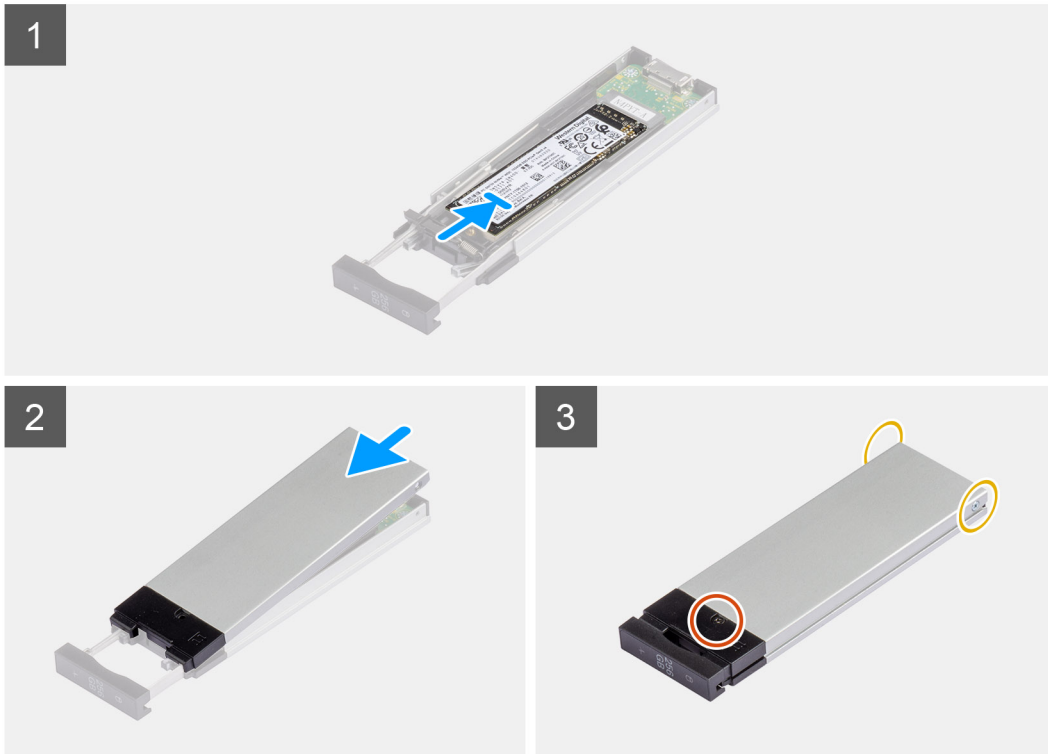

### Steps

1. Align the notch on the solid-state drive with the tab on the solid-state drive connector.
2. Insert the solid-state drive at a 45-degree angle into the slot on the solid-state drive assembly.
3. Place the cover over the solid-state drive assembly.
4. Install the single (M3x6) screw and the two (M3x3) screws to secure the cover to the solid-state drive assembly.

### Next steps

1. Follow the procedure in [After working inside your computer](#).

## Installing the external solid-state drive assembly

### Prerequisites

If you are replacing a component, remove the existing component before performing the installation procedure.

### About this task

The following images indicate the location of the external solid-state drive assembly and provide a visual representation of the installation procedure.



### Steps

1. Slide and insert the solid-state drive assembly into the external flexbay slot.
2. Push and close the release latch to secure the solid-state drive assembly in place.

### Next steps

1. Follow the procedure in [After working inside your computer](#).

## Slim optical-drive

### Removing the slim optical-drive

#### Prerequisites

1. Follow the procedure in [Before working inside your computer](#).
2. Remove the [side cover](#).

#### About this task

The following images indicate the location of the slim optical-drive and provide a visual representation of the removal procedure.

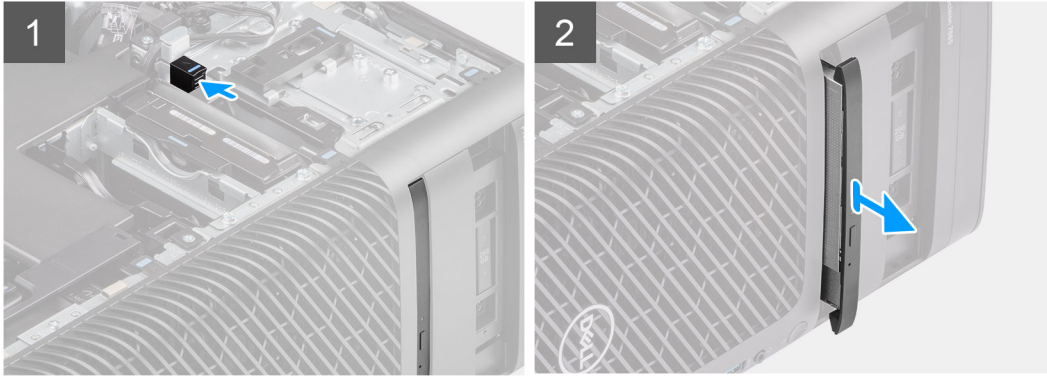

### Steps

1. Push the slim optical-drive latch to release it from the flexbay.
2. Slide and remove the slim optical-drive from the slot on the flexbay.

## Installing the slim optical-drive

### Prerequisites

If you are replacing a component, remove the existing component before performing the installation procedure.

### About this task

The following images indicate the location of the slim optical-drive and provide a visual representation of the installation procedure.

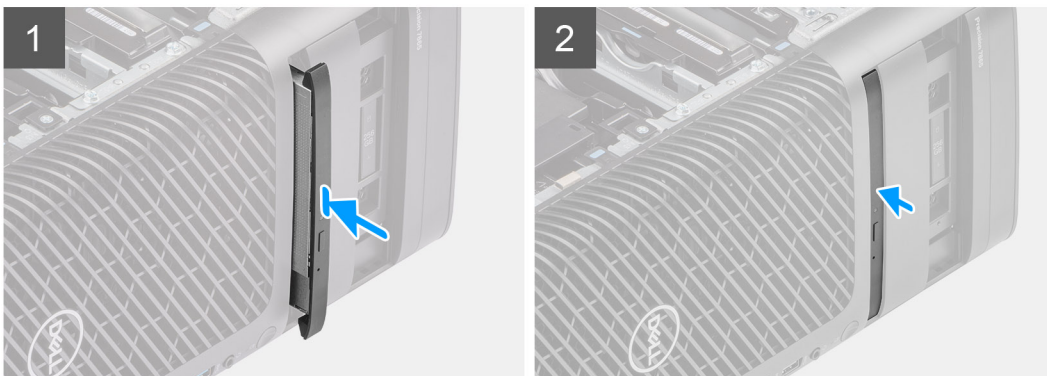

### Steps

1. Insert the slim optical-drive into the slot in the flexbay.
2. Push the slim optical-drive until it snaps into place.

### Next steps

1. Install the [side cover](#).
2. Follow the procedure in [After working inside your computer](#).

## Air shroud

### Removing the air shroud

#### Prerequisites

1. Follow the procedure in [Before working inside your computer](#).
2. Remove the [side cover](#).

#### About this task

The following image indicates the location of the air shroud and provides a visual representation of the removal procedure.

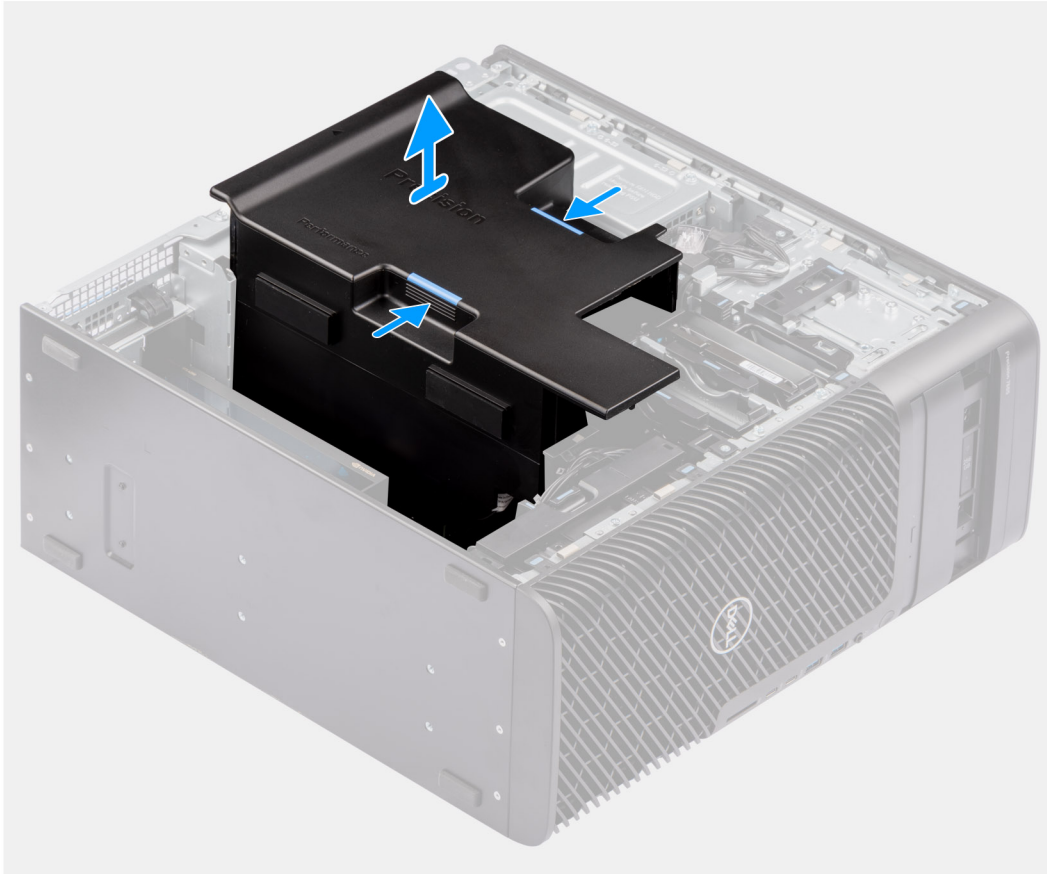

### Steps

1. Hold the air shroud at the gripping points.
2. Pull the air shroud upwards and out of the computer.

## Installing the air shroud

### Prerequisites

If you are replacing a component, remove the existing component before performing the installation procedure.

### About this task

The following image indicates the location of the air shroud and provides a visual representation of the installation procedure.

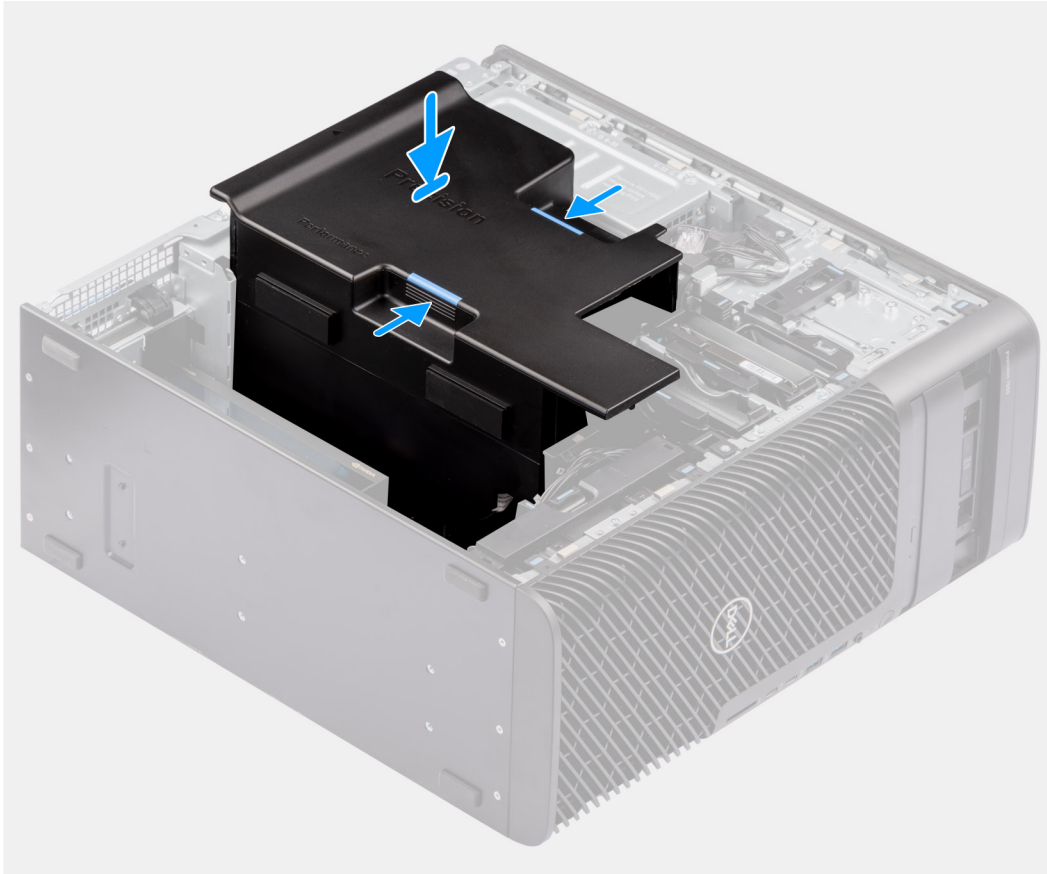

### Steps

1. Align the air shroud over the heat-sink and system board holding and seat it in the slot.
2. Press the air shroud down until the tabs click into place.

### Next steps

1. Install the [side cover](#).
2. Follow the procedure in [After working inside your computer](#).

## PCIe holder

### Removing the PCIe holder

#### Prerequisites

1. Follow the procedure in [Before working inside your computer](#).
2. Remove the [side cover](#).
3. Remove the [air shroud](#).

### About this task

The following images indicate the location of the PCIe holder and provide a visual representation of the removal procedure.

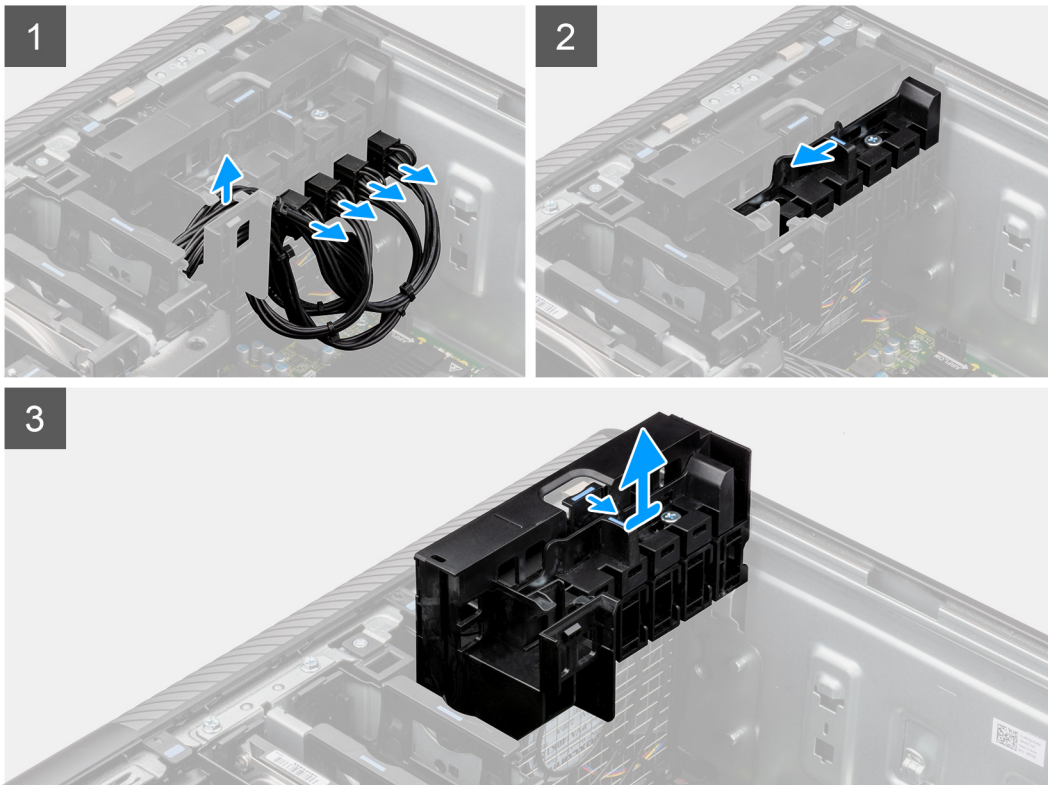
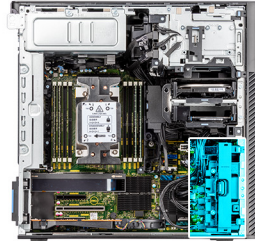

### Steps

1. Remove the PCIe-power cables from the slots on the PCIe holder.
2. Push the PCIe holder lock into the unlock position.
3. Push the latch towards the PCIe holder lock, then lift and remove the PCIe holder out of the computer.

## Installing the PCIe holder

### Prerequisites

If you are replacing a component, remove the existing component before performing the installation procedure.

### About this task

The following images indicate the location of the PCIe holder and provide a visual representation of the installation procedure.

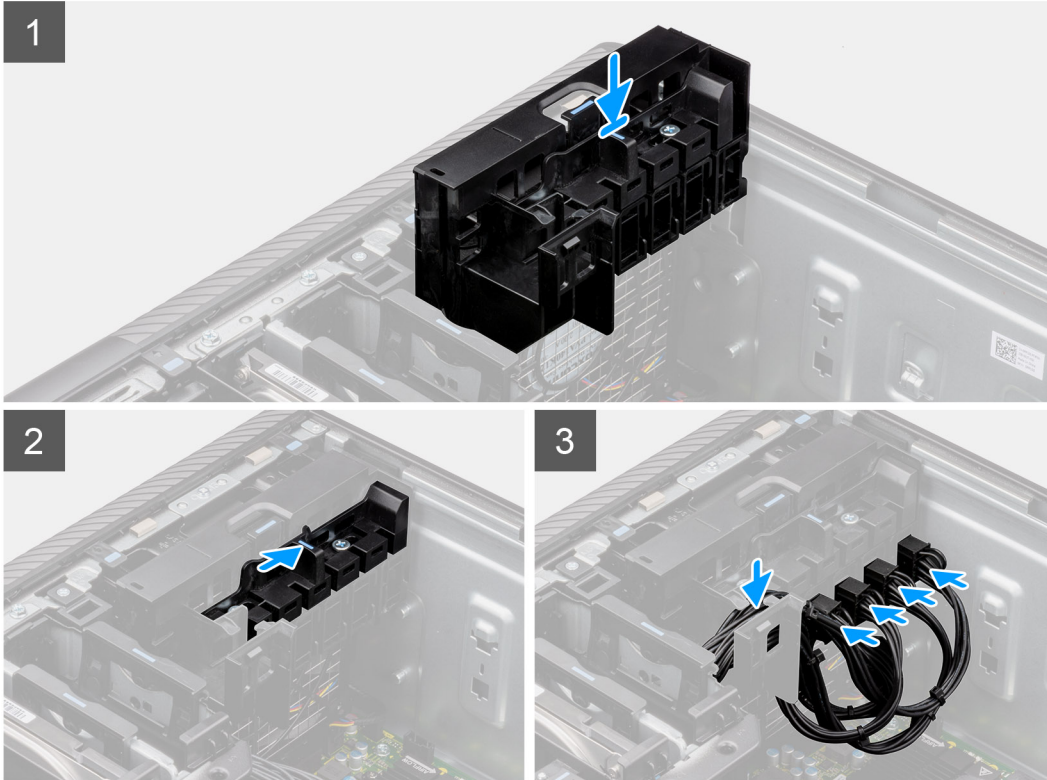

### Steps

1. Align and place the PCIe holder on the slot over the front fan.
2. Push the PCIe holder lock into the lock position to secure the PCIe holder to the chassis.
3. Reconnect the PCIe-power cables to the slots on the PCIe holder.

### Next steps

1. Install the [air shroud](#).
2. Install the [side cover](#).
3. Follow the procedure in [After working inside your computer](#).

## Front fan

### Removing the front-fan assembly

#### Prerequisites

1. Follow the procedure in [Before working inside your computer](#).
2. Remove the [side cover](#).
3. Remove the [PCIe holder](#).

### About this task

The following images indicate the location of the front-fan assembly and provide a visual representation of the removal procedure.



1x  
M3x5

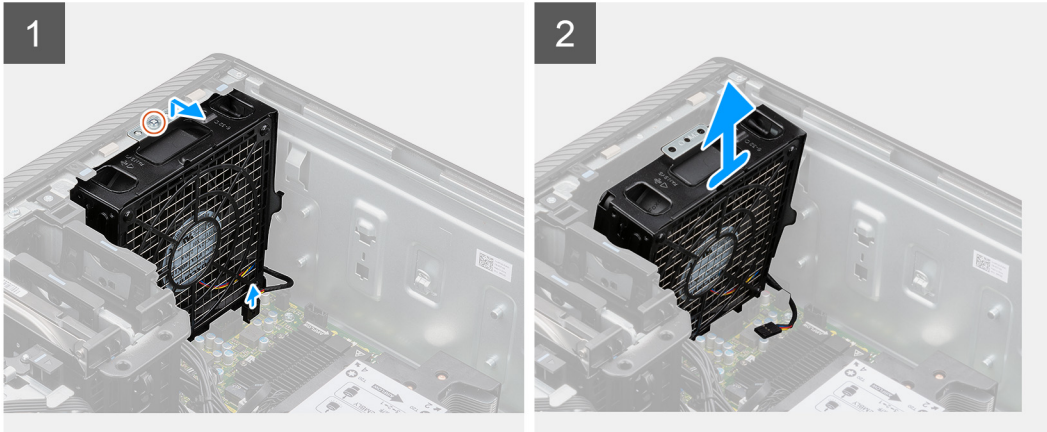
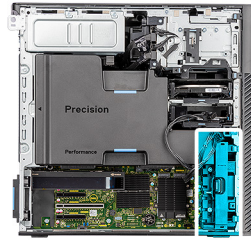

### Steps

1. Remove the single (M3x5) screw from the fan assembly.
2. Disconnect the fan cable from the connector on the system board.
3. Move the fan assembly at an angle from the chassis.
4. Lift and remove the fan assembly from the computer.

## Removing front fan

### Prerequisites

1. Follow the procedure in [Before working inside your computer](#).
2. Remove the [front-fan assembly](#).

### About this task

The following images indicate the location of the front fan and provide a visual representation of the removal procedure.

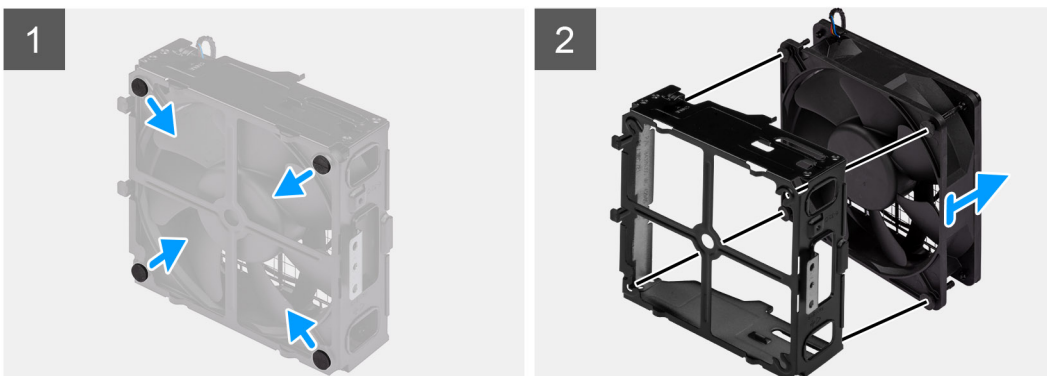

### Steps

1. Locate the position of rubber grommets.
2. Gently pull the rubber grommets to release the fan from the fan cage.
3. Remove the fan from the fan cage.

## Installing the front fan

### Prerequisites

If you are replacing a component, remove the existing component before performing the installation procedure.

### About this task

The following images indicate the location of the front fan and provide a visual representation of the installation procedure.

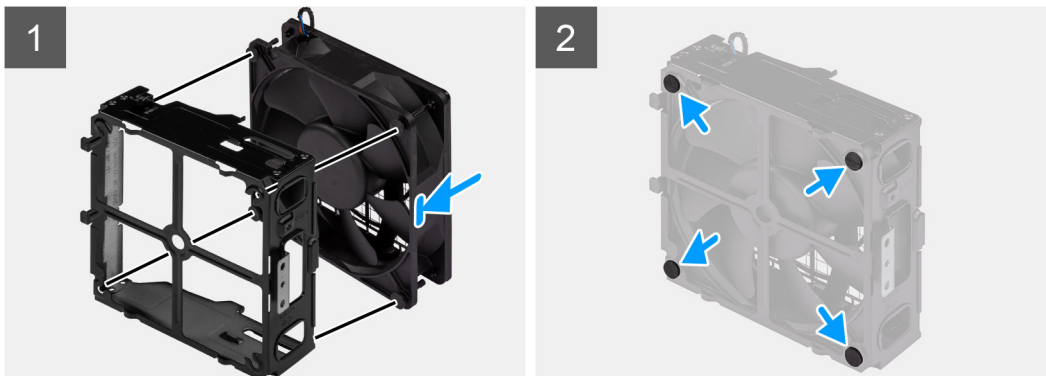

### Steps

1. Insert the rubber grommets on the fan cage.
2. Align the slots on the fan with the rubber grommets on the fan cage.
3. Route the rubber grommets through the slots on the fan and pull the rubber grommets until the fan snaps into position.

### Next steps

1. Install the [front-fan assembly](#).
2. Follow the procedure in [After working inside your computer](#).

## Installing the front-fan assembly

### Prerequisites

If you are replacing a component, remove the existing component before performing the installation procedure.

### About this task

The following images indicate the location of the front-fan assembly and provide a visual representation of the installation procedure.



1x  
M3x5

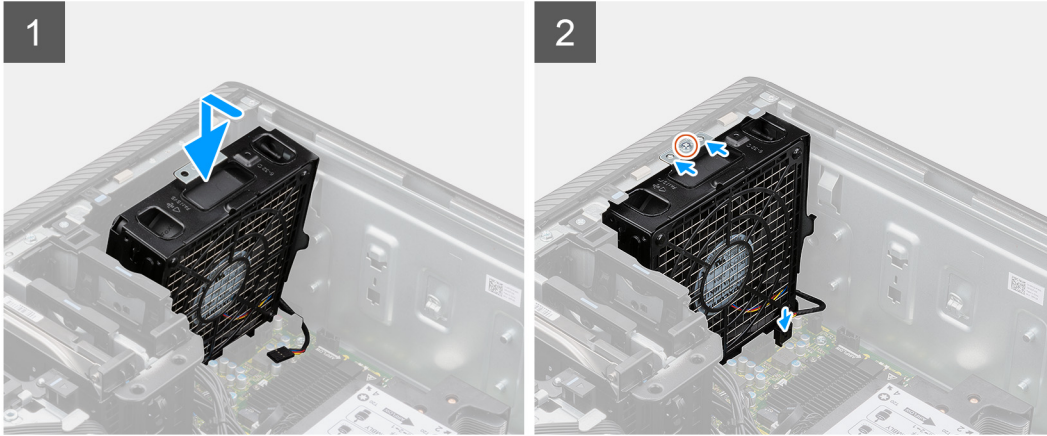
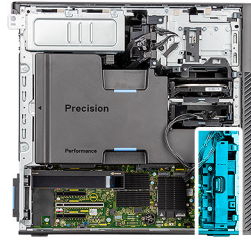

### Steps

1. Align the tabs on the fan assembly with the slots on the chassis.
2. Insert the fan assembly at an angle into the slot in the chassis.
3. Install the single (M3x5) screw to secure the fan assembly to the chassis.
4. Connect the fan cable to the connector on the system board.

### Next steps

1. Install the [PCIe holder](#).
2. Install the [side cover](#).
3. Follow the procedure in [After working inside your computer](#).

## 3.5-inch hard-drive assembly

### Removing the 3.5-inch hard-drive assembly

#### Prerequisites

1. Follow the procedure in [Before working inside your computer](#).
2. Remove the [side cover](#).

#### About this task

The following images indicate the location of the 3.5-inch hard-drive assembly and provide a visual representation of the removal procedure.

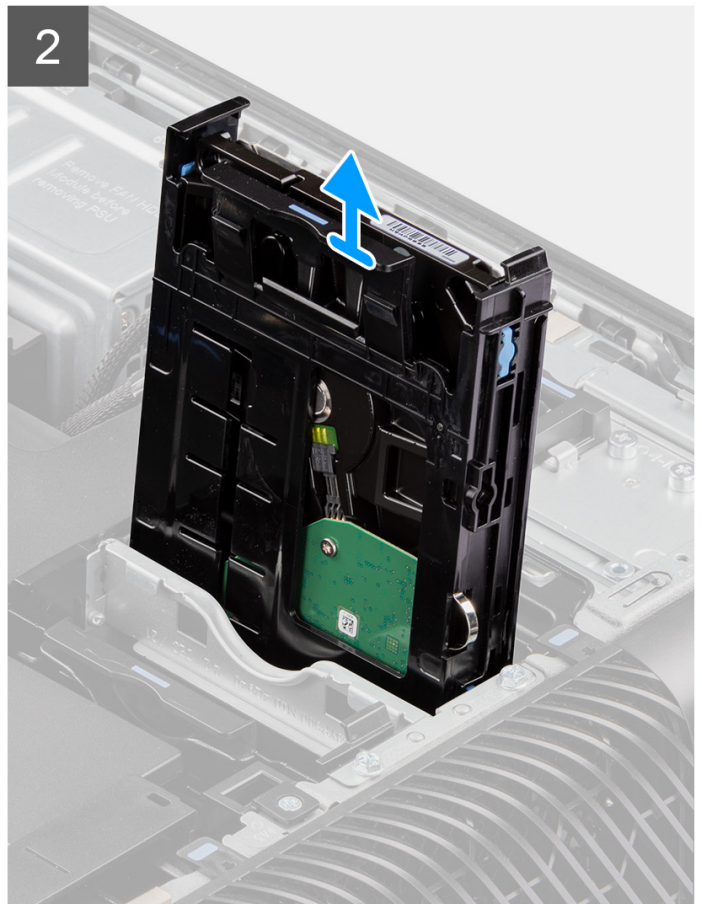
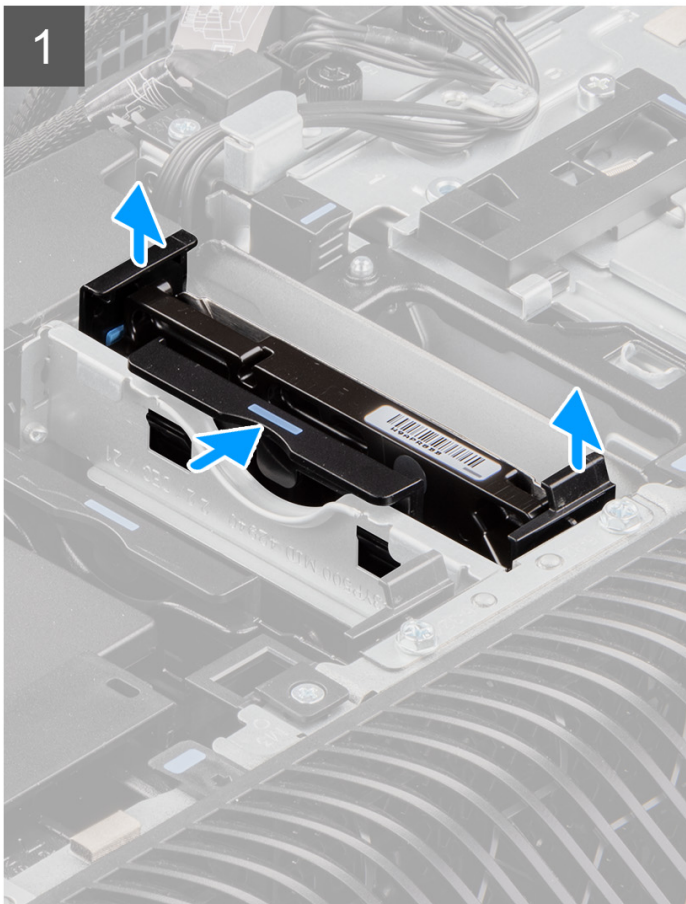
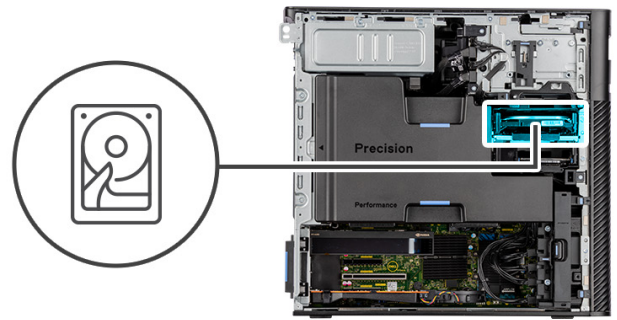

### Steps

1. Press the securing tabs to release the hard-drive assembly from the chassis.
2. Slide the hard-disk drive assembly out of the hard-drive bracket.

## Removing the 3.5-inch hard-drive bracket

### Prerequisites

1. Follow the procedure in [before working inside your computer](#).
2. Remove the [side cover](#).
3. Remove the [3.5-inch hard-drive assembly](#).

### About this task

The following images indicate the location of the 3.5-inch hard-drive bracket and provide a visual representation of the removal procedure.

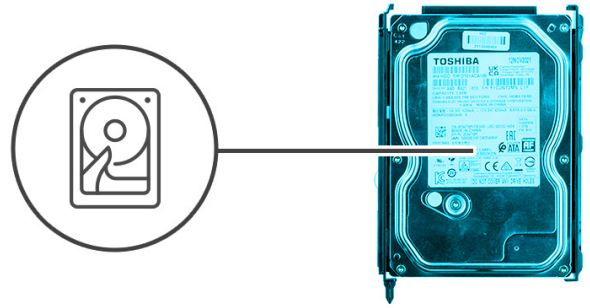

### Steps

1. Pry the sides of the hard-drive bracket to release the tabs on the bracket from the slots on the hard drive.
2. Lift and remove the hard drive off the hard-drive bracket.

## Installing the 3.5-inch hard-drive bracket

### Prerequisites

If you are replacing a component, remove the existing component before performing the installation procedure.

### About this task

The following images indicate the location of the 3.5-inch hard-drive bracket and provide a visual representation of the installation procedure.

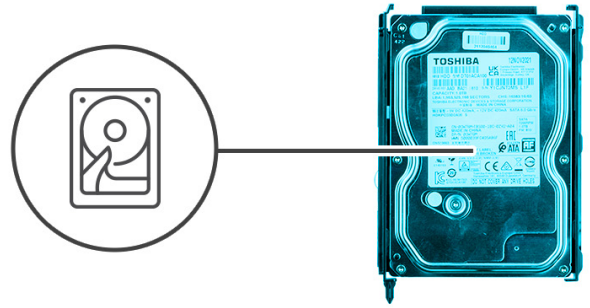

### Steps

1.  **NOTE:** If your hard-drive bracket is installed with an adapter for 2.5-inch drives, remove the adapter before installing a 3.5-inch drive.  
Place the hard drive into the hard-drive bracket and align the tabs on the bracket with the slots on the hard drive.
2. Snap the hard-drive into the hard-drive bracket.

### Next steps

1. Install the [3.5-inch hard-drive assembly](#).
2. Install the [side cover](#).
3. Follow the procedure in [after working inside your computer](#).

## Installing the 3.5-inch hard-drive assembly

### Prerequisites

If you are replacing a component, remove the existing component before performing the installation procedure.

### About this task

The following images indicate the location of the 3.5-inch hard-drive assembly and provide a visual representation of the installation procedure.

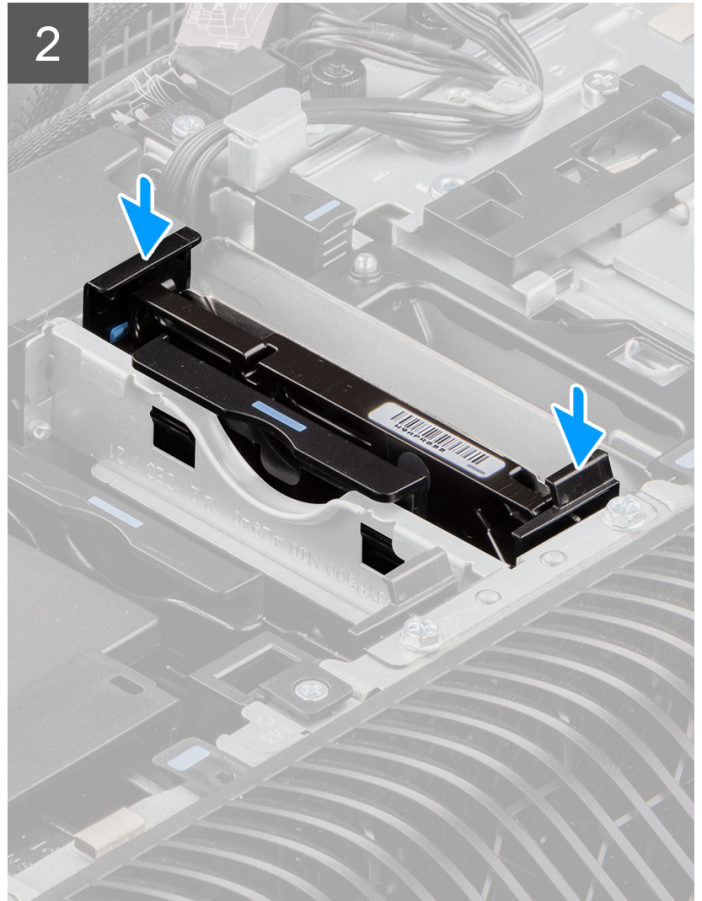
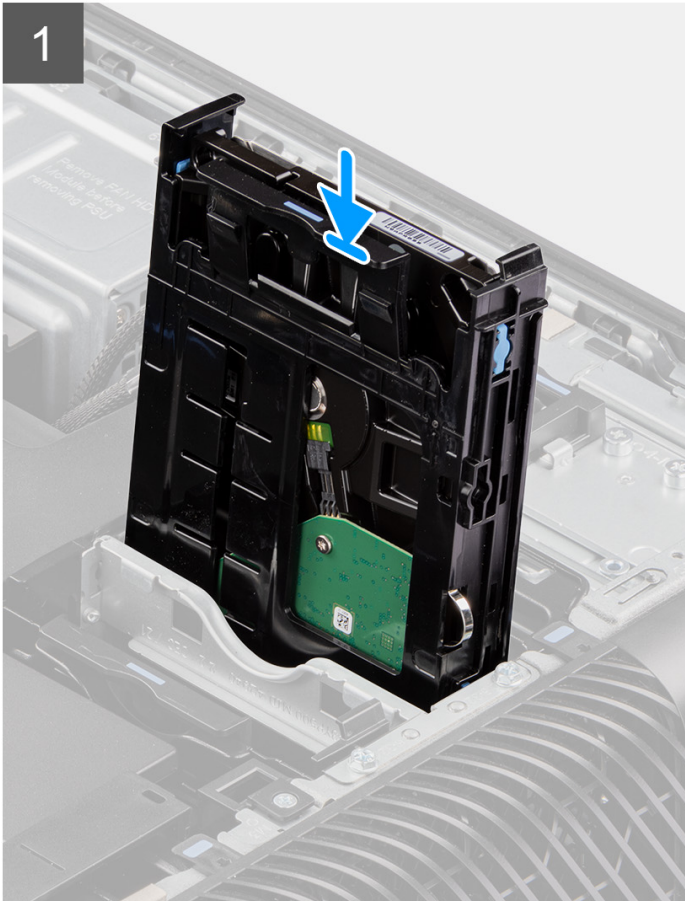
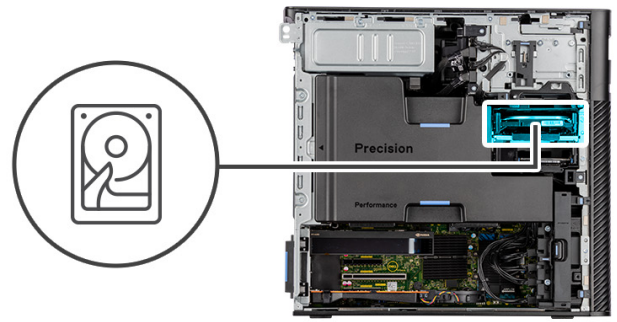

### Steps

Slide and insert the 3.5-inch hard-drive assembly into the slot on the hard-drive bracket.

**i** **NOTE:** Push the hard-drive assembly into the slot until you hear a 'click' sound, which indicates that the assembly is locked into position.

### Next steps

1. Install the [side cover](#).
2. Follow the procedure in [After working inside your computer](#).

# 2.5-inch hard-drive assembly

## Removing the 2.5-inch hard-drive assembly

### Prerequisites

1. Follow the procedure in [Before working inside your computer](#).
2. Remove the [side cover](#).

### About this task

The following images indicate the location of the 2.5-inch hard-drive assembly and provide a visual representation of the removal procedure.

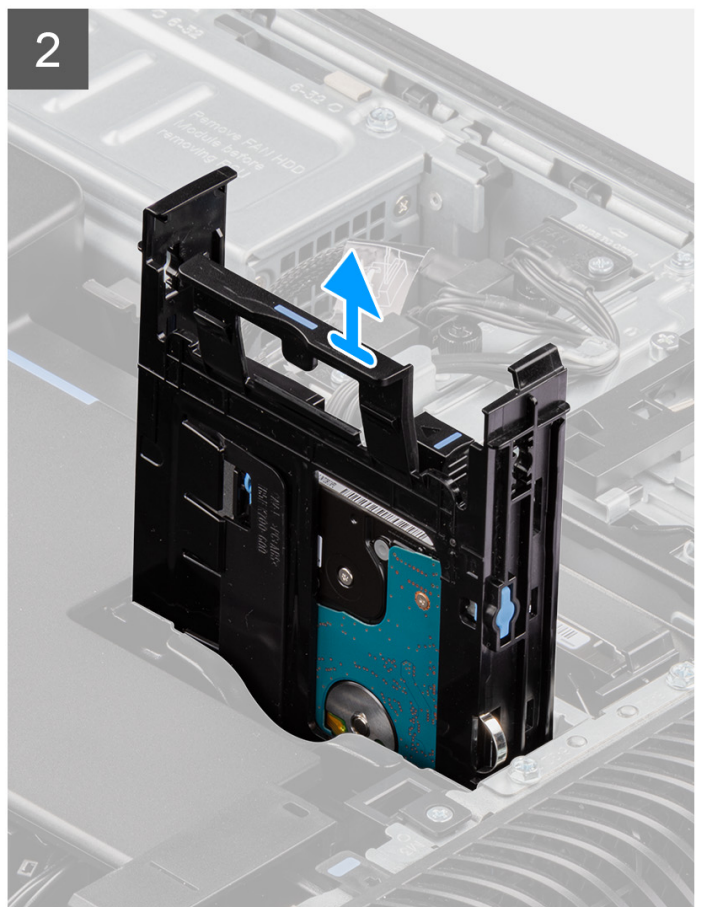
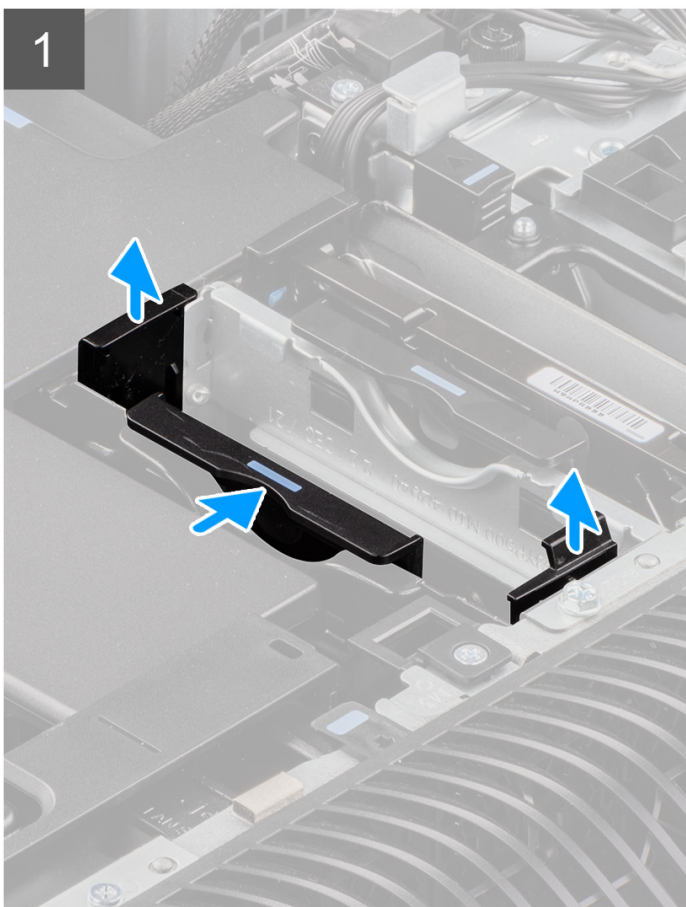
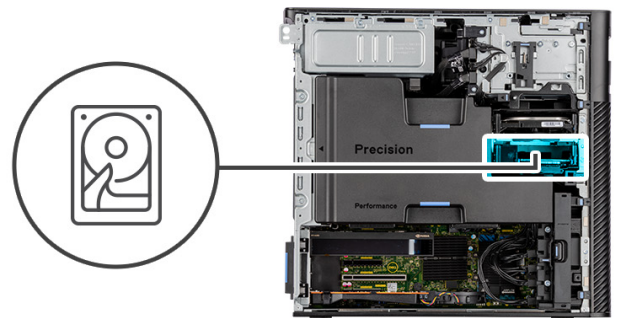

### Steps

1. Press the securing tabs to release the hard-drive assembly from the chassis.

2. Slide the hard-disk drive assembly out of the hard-drive bracket.

## Removing the 2.5-inch hard-disk drive bracket

### Prerequisites

1. Follow the procedure in [Before working inside your computer](#).
2. Remove the [side cover](#).
3. Remove the [2.5-inch hard-drive assembly](#).

### About this task

The following images indicate the location of the 2.5-inch hard-drive bracket and provide a visual representation of the removal procedure.

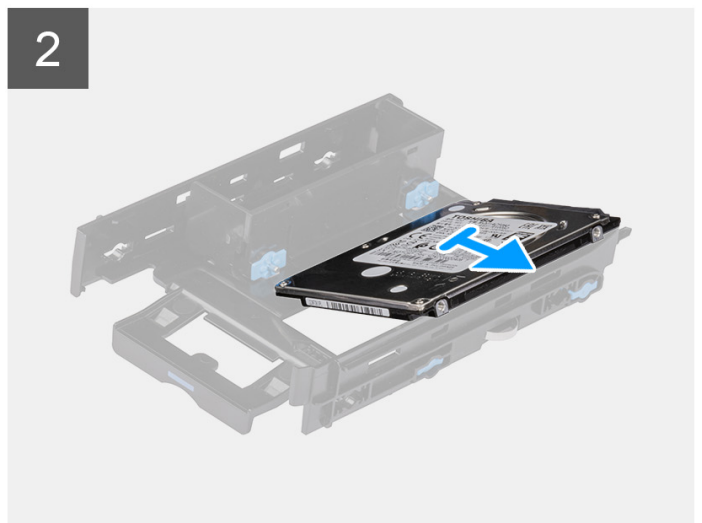
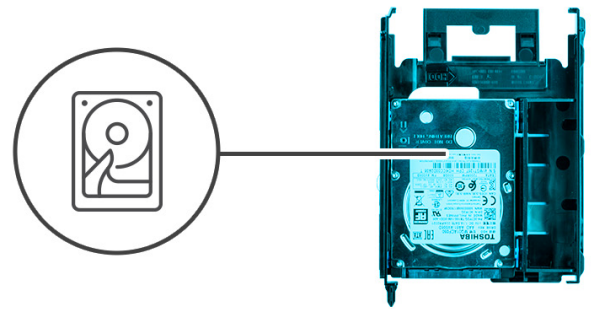

### Steps

1. Pry the sides of the hard-drive bracket to release the tabs on the bracket from the slots on the hard drive.
2. Lift and remove the hard drive off the hard-drive bracket.

## Installing the 2.5-inch hard-drive bracket

### Prerequisites

If you are replacing a component, remove the existing component before performing the installation procedure.

### About this task

The following images indicate the location of the 2.5-inch hard-drive bracket and provide a visual representation of the installation procedure.

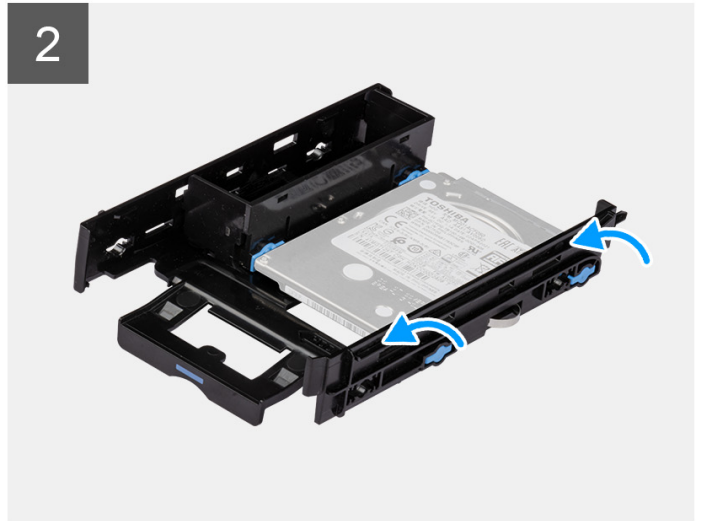
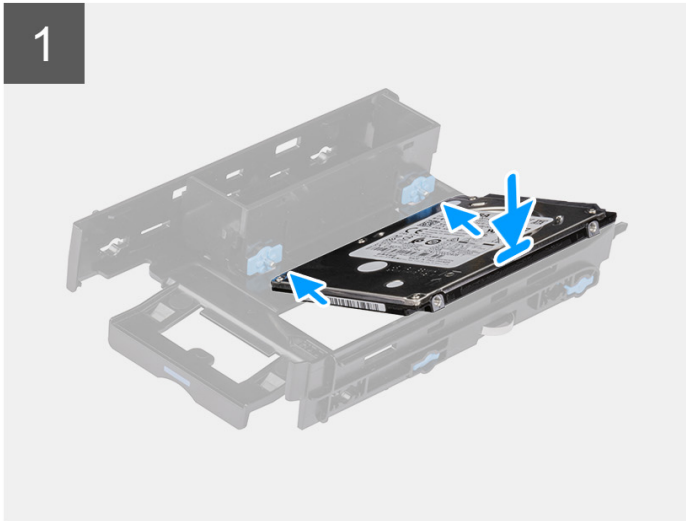
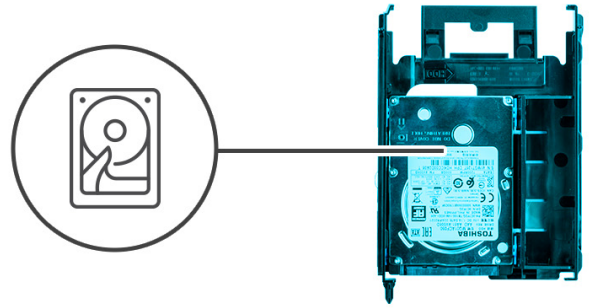

### Steps

1. Place the hard drive into the hard-drive bracket and align the tabs on the bracket with the slots on the hard drive.
2. Snap the hard-drive into the hard-drive bracket.

### Next steps

1. Install the [2.5-inch hard-drive assembly](#).
2. Install the [side cover](#).
3. Follow the procedure in [After working inside your computer](#).

## Installing the 2.5-inch hard-drive assembly

### Prerequisites

If you are replacing a component, remove the existing component before performing the installation procedure.

### About this task

The following images indicate the location of the 2.5-inch hard-drive assembly and provide a visual representation of the installation procedure.

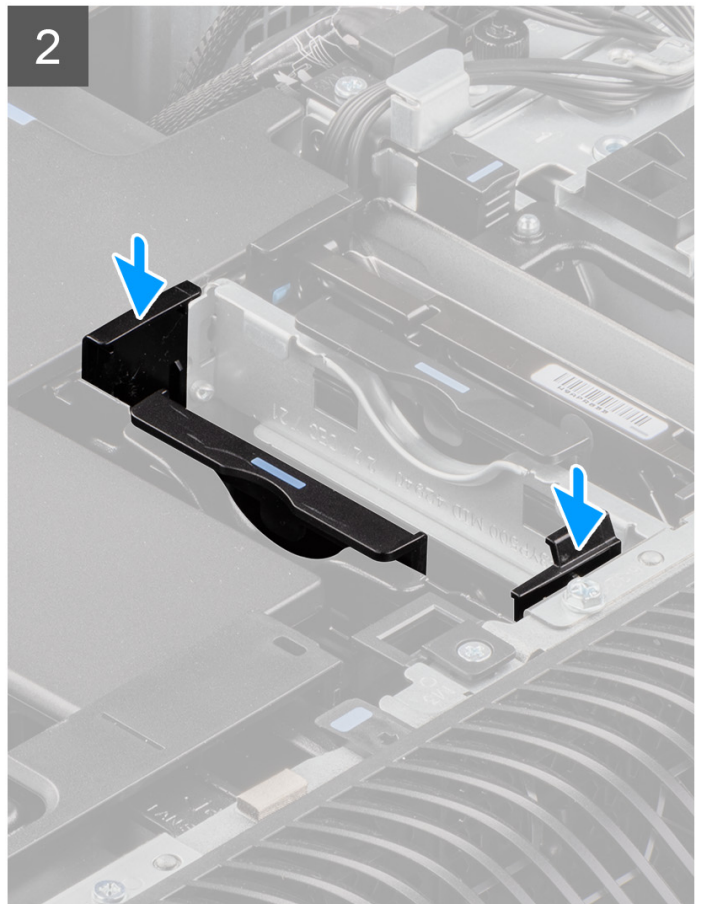
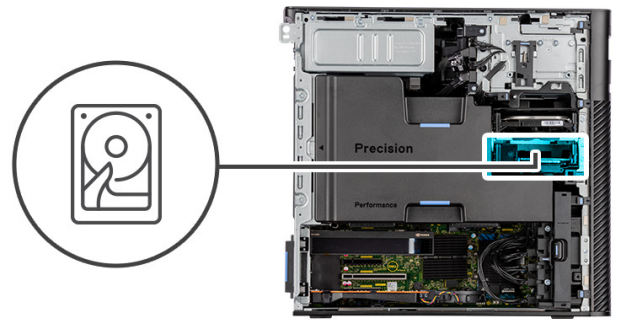

### Steps

Slide and insert the hard-drive assembly into the slot on the hard-drive bracket.

### Next steps

1. Install the [side cover](#).
2. Follow the procedure in [After working inside your computer](#).

## Hard-drive fan assembly

### Removing the hard-drive fan assembly

#### Prerequisites

1. Follow the procedure in [Before working inside your computer](#).

2. Remove the [side cover](#).
3. Remove the [air shroud](#).

### About this task

The following images indicate the location of the hard-drive fan assembly and provide a visual representation of the removal procedure.



2x  
M3

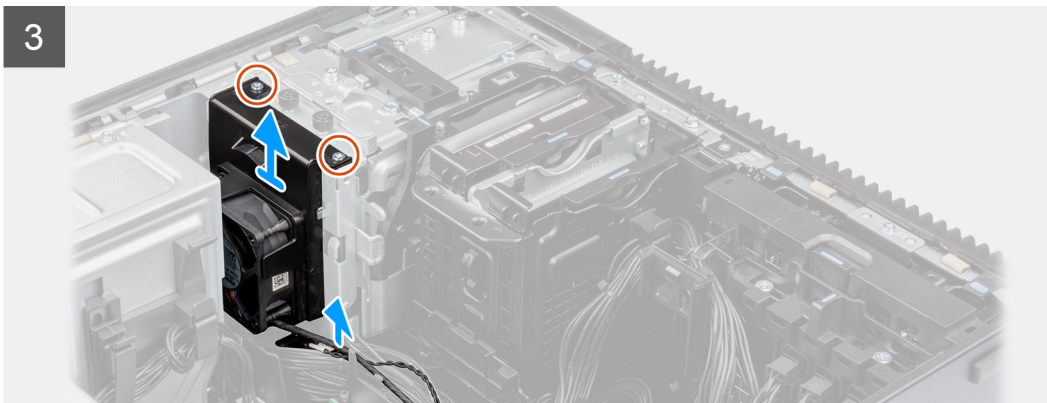
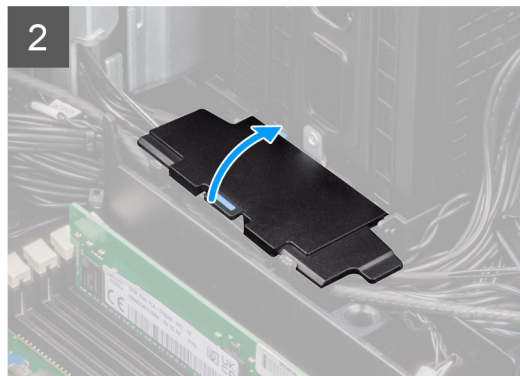
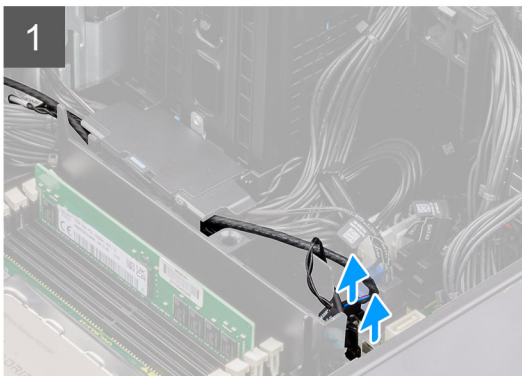

### Steps

1. Disconnect the SATA power-cable, thermal-sensor cable, PCIe cable and the fan-controller cable from the connectors on the system board.
2. Open the bottom-air shroud cover and remove the cables that are routed inside.
3. Remove the two (M3) screws from the hard-drive fan assembly.
4. Lift and remove the hard-drive fan assembly from the computer.

## Installing the hard-drive fan assembly

### Prerequisites

If you are replacing a component, remove the existing component before performing the installation procedure.

## About this task

The following images indicate the location of the hard-drive fan assembly and provide a visual representation of the installation procedure.



2x  
M3

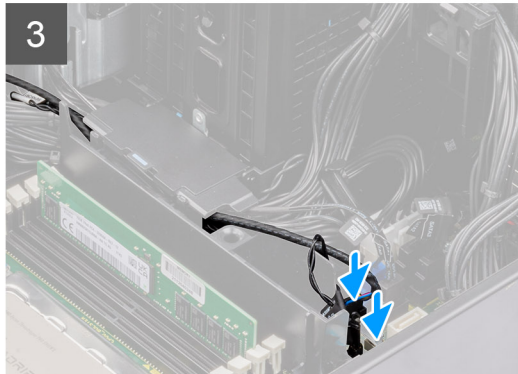
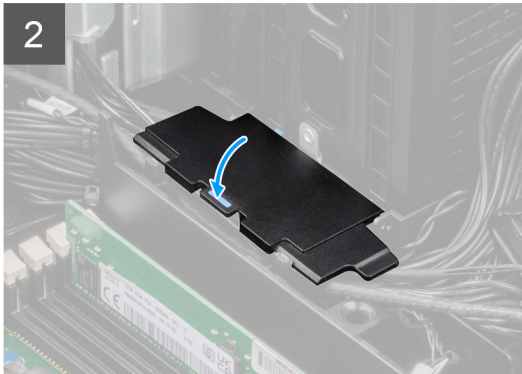
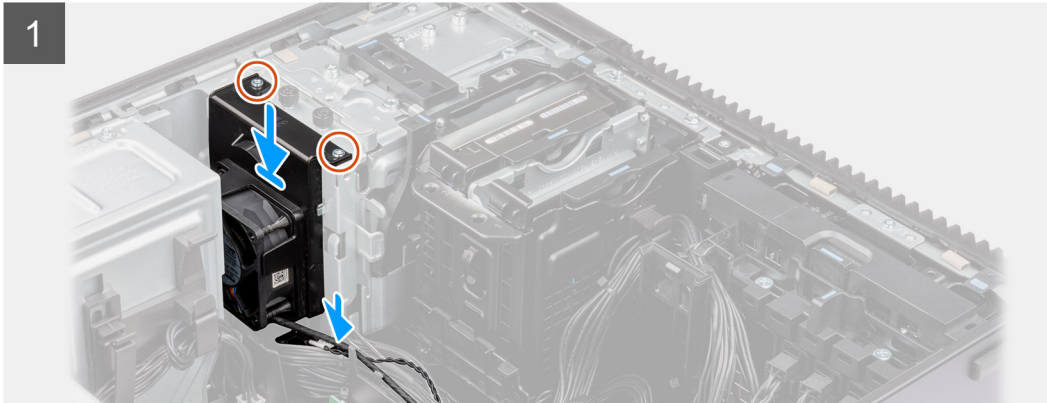

## Steps

1. Align the tabs on the hard-drive fan assembly with the slots on the chassis.
2. Place the hard-drive fan assembly into the slot in the chassis.
3. Install the two (M3) screws to secure the fan assembly to the chassis.
4. Route the SATA power-cable, thermal-sensor cable, PCIe cable and fan-controller cable through the bottom air-shroud cover.
5. Close the lid of the bottom air-shroud cover.
6. Connect the SATA power-cable, thermal-sensor cable, PCIe cable and fan-controller cable to the connectors on the system board.

## Next steps

1. Install the [air shroud](#).
2. Install the [side cover](#).
3. Follow the procedure in [After working inside your computer](#).

# Bottom air-shroud

## Removing the bottom air-shroud

### Prerequisites

1. Follow the procedure in [Before working inside your computer](#).
2. Remove the [side cover](#).
3. Remove the [air shroud](#).

### About this task

The following image indicates the location of the air shroud and provides a visual representation of the removal procedure.

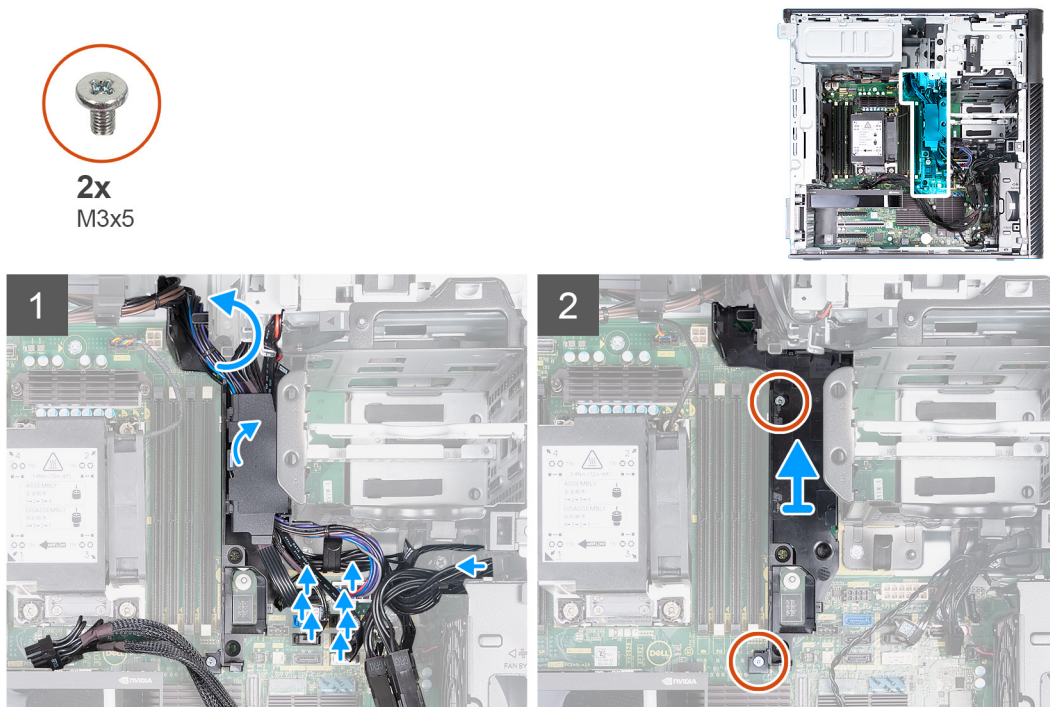

### Steps

1. Release the cables from the front chassis.
2. Pull and release the tab on the bottom air-shroud cover and remove the cover from the computer.
3. Remove cables from the routing guides on the system board.
4. Remove the two (M3x5) screws that secures the bottom air-shroud to the system board.
5. Remove the bottom air-shroud upwards and out of the computer.

## Installing the bottom air-shroud

### Prerequisites

If you are replacing a component, remove the existing component before performing the installation procedure.

### About this task

The following image indicates the location of the air shroud and provides a visual representation of the installation procedure.



2x  
M3x5

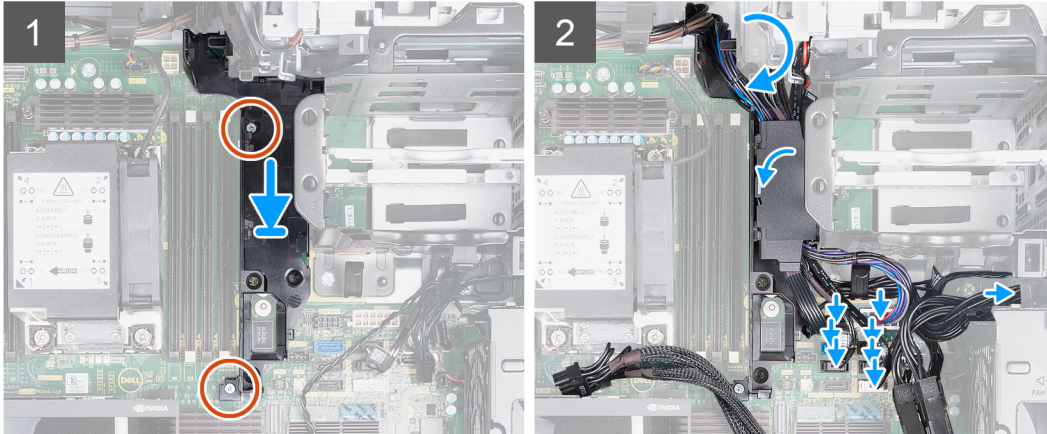

### Steps

1. Align the bottom air-shroud with the slot on the system board.
2. Replace the two (M3x5) screws that secures the bottom air-shroud to the system board.
3. Connect the cables to the front chassis.
4. Route the cables through the routing guides on the system board.
5. Place and lock the bottom air-shroud cover.

### Next steps

1. Install the [air shroud](#).
2. Install the [side cover](#).
3. Follow the procedure in [After working inside your computer](#).

## Internal hard-drive cage

### Removing the internal hard-drive cage

#### Prerequisites

1. Follow the procedure in [Before working inside your computer](#).
2. Remove the [side cover](#).
3. Remove the [air shroud](#).
4. Remove the [2.5-inch hard-drive assembly](#).
5. Remove the [3.5-inch hard-drive assembly](#).
6. Remove the [hard-drive fan assembly](#)
7. Remove the [bottom air-shroud](#).

#### About this task

The following images indicate the location of the internal hard-drive cage and provide a visual representation of the removal procedure.



5x  
#6-32

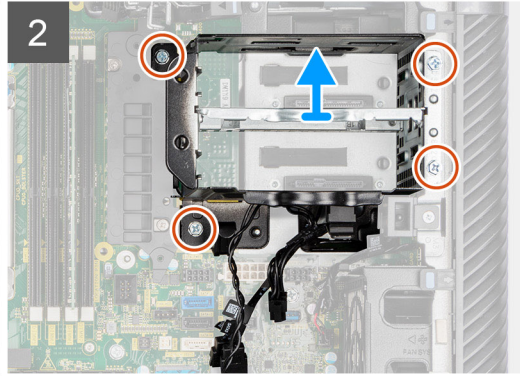
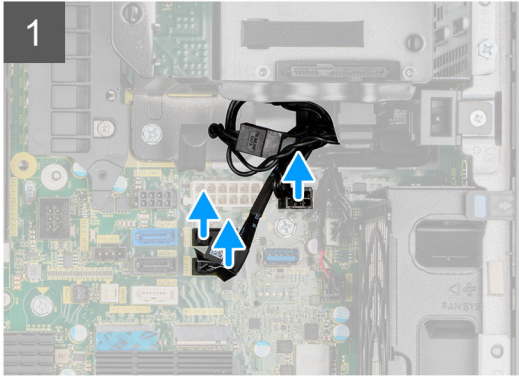

### Steps

1. Disconnect the SATA power-cables and SATA data-cables from the connectors on the system board.
2. Remove the five (#6-32) screws from the hard-drive cage.
3. Slide and remove the hard-drive cage out of the computer.

## Installing the internal hard-drive cage

### Prerequisites

If you are replacing a component, remove the existing component before performing the installation procedure.

### About this task

The following images indicate the location of the internal hard-drive cage and provide a visual representation of the installation procedure.



5x  
#6-32

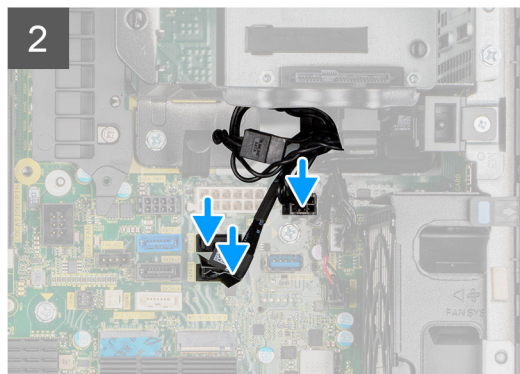
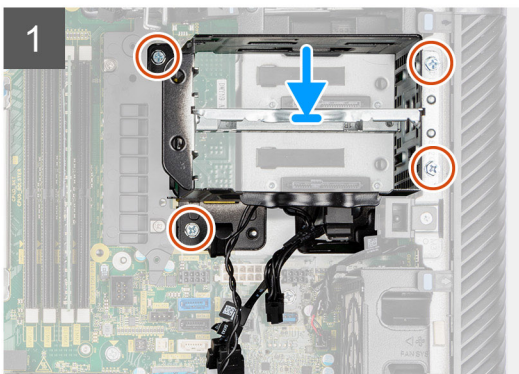

### Steps

1. Slide and insert the hard-drive cage into the slot on the chassis.
2. Install the four (#6-32) screws to secure the hard-drive cage to the chassis.
3. Connect the SATA power-cables and SATA data-cables to the connectors on the system board.

### Next steps

1. Install the [bottom air-shroud](#)
2. Install the [hard-drive fan assembly](#).
3. Install the [3.5-inch hard-drive assembly](#).
4. Install the [2.5-inch hard-drive assembly](#).
5. Install the [air shroud](#).
6. Install the [side cover](#).
7. Follow the procedure in [After working inside your computer](#).

## Rear fans

### Removing the rear-fan assembly

#### Prerequisites

1. Follow the procedure in [Before working inside your computer](#).
2. Remove the [side cover](#).
3. Remove the [air shroud](#).

#### About this task

The following images indicate the location of the rear-fan assembly and provide a visual representation of the removal procedure.



2x  
#6-32

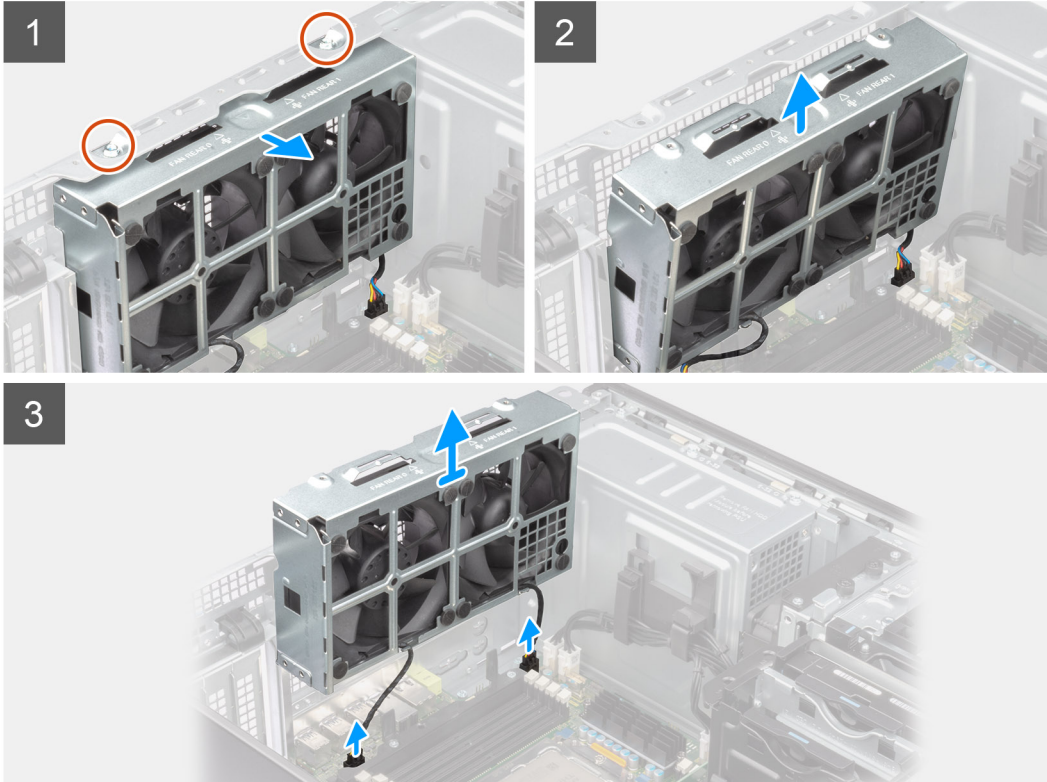
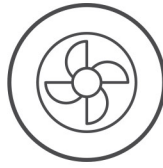

### Steps

1. Remove the two (#6-32) screws from the fan assembly.
2. Move the fan assembly at an angle from the chassis.
3. Disconnect the two fan cables from the connectors on the system board.
4. Lift and remove the fan assembly from the computer.

## Removing rear fan

### Prerequisites

1. Follow the procedure in [Before working inside your computer](#).
2. Remove the [rear-fan assembly](#).

### About this task

The following images indicate the location of the front-fan cage and provide a visual representation of the removal procedure.

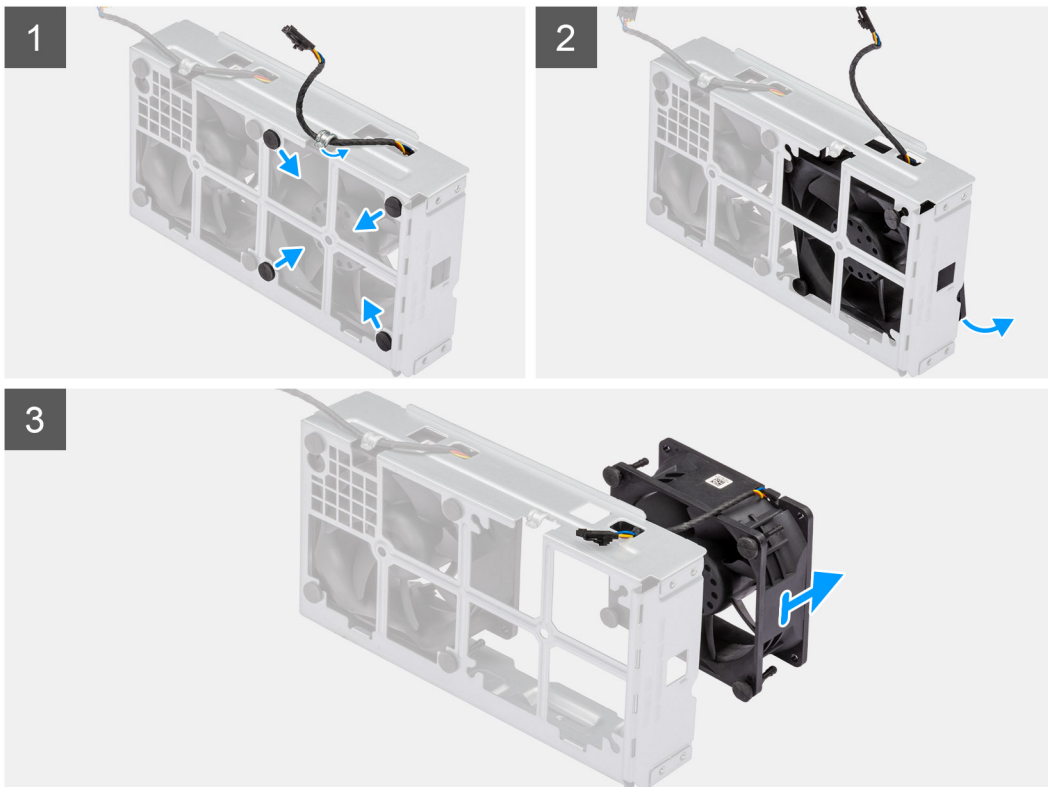

### Steps

1. Remove the fan cable from the routing guide on the fan assembly.
2. Locate the position of rubber grommets.
3. Gently pull the rubber grommets inwards to release the fan from the fan cage.
4. Remove the fan from the fan cage.

**i** **NOTE:** Follow the same steps for the second fan.

## Installing the rear fan

### Prerequisites

If you are replacing a component, remove the existing component before performing the installation procedure.

### About this task

The following images indicate the location of the rear fan and provide a visual representation of the installation procedure.

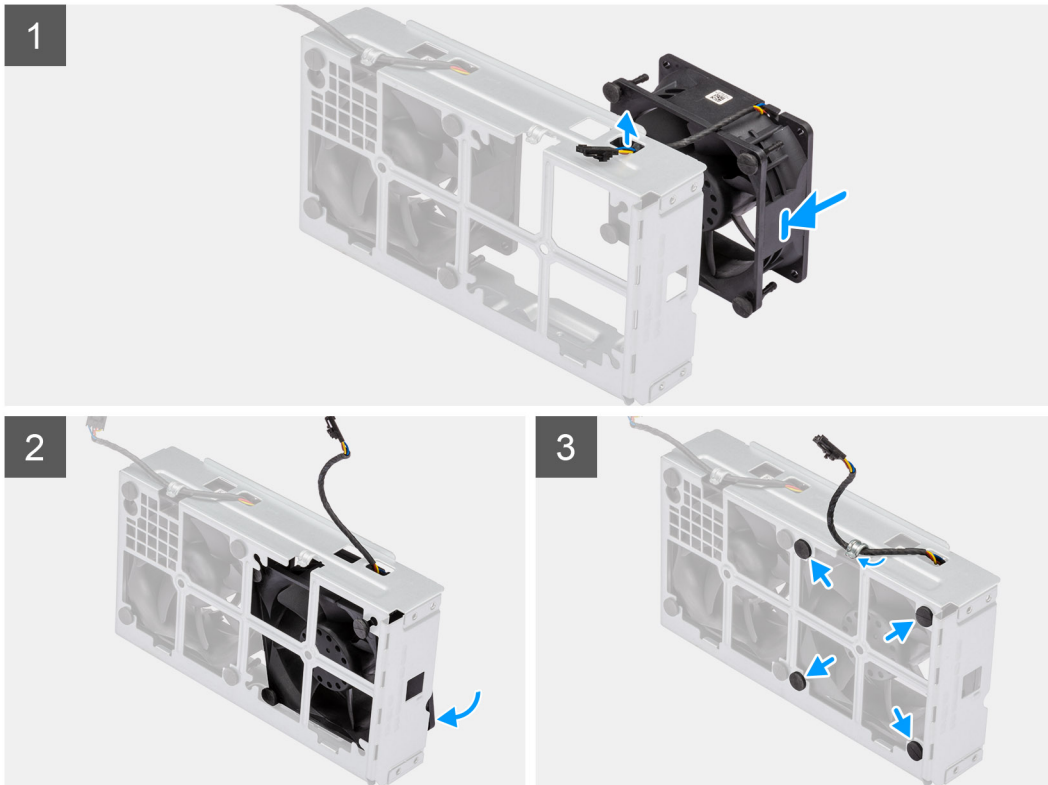

### Steps

1. Route the fan cable through the slot on the fan cage.
2. Place the fan inside the fan cage.
3. Insert the rubber grommets on the fan cage.
4. Align the slots on the fan with the rubber grommets on the fan cage.
5. Route the rubber grommets through the slots on the fan and pull the rubber grommets until the fan snaps into position.

### Next steps

1. Install the [rear-fan assembly](#).
2. Follow the procedure in [After working inside your computer](#).

## Installing the rear-fan assembly

### Prerequisites

If you are replacing a component, remove the existing component before performing the installation procedure.

### About this task

The following images indicate the location of the rear-fan assembly and provide a visual representation of the installation procedure.



2x  
#6-32

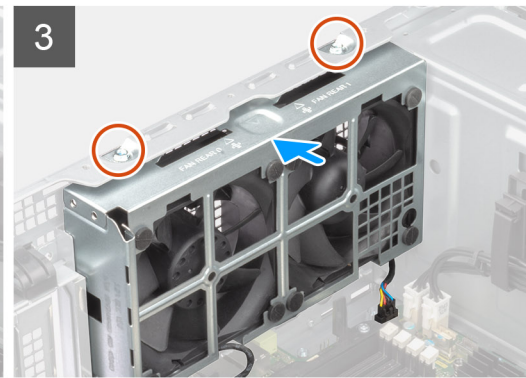
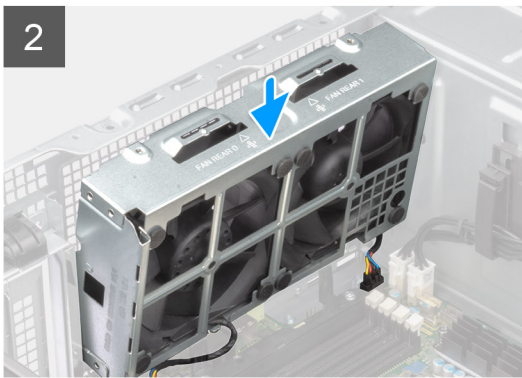
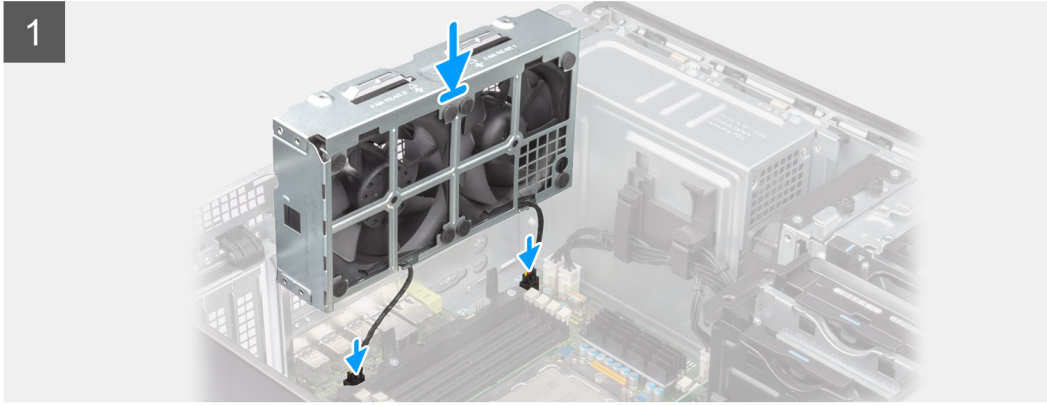
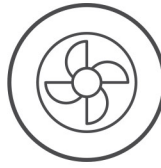

### Steps

1. Align the tabs on the fan assembly with the slots on the chassis.
2. Insert the fan assembly at an angle into the slot in the chassis.
3. Install the two (#6-32) screws to secure the fan assembly to the chassis.
4. Connect the fan cable to the connector on the system board.

### Next steps

1. Install the [air shroud](#).
2. Install the [side cover](#).
3. Follow the procedure in [After working inside your computer](#).

## Memory modules

### Removing the memory module

#### Prerequisites

1. Follow the procedure in [Before working inside your computer](#).
2. Remove the [side cover](#).
3. Remove the [air shroud](#).

### About this task

The following image indicates the location of the memory module and provide a visual representation of the removal procedure.

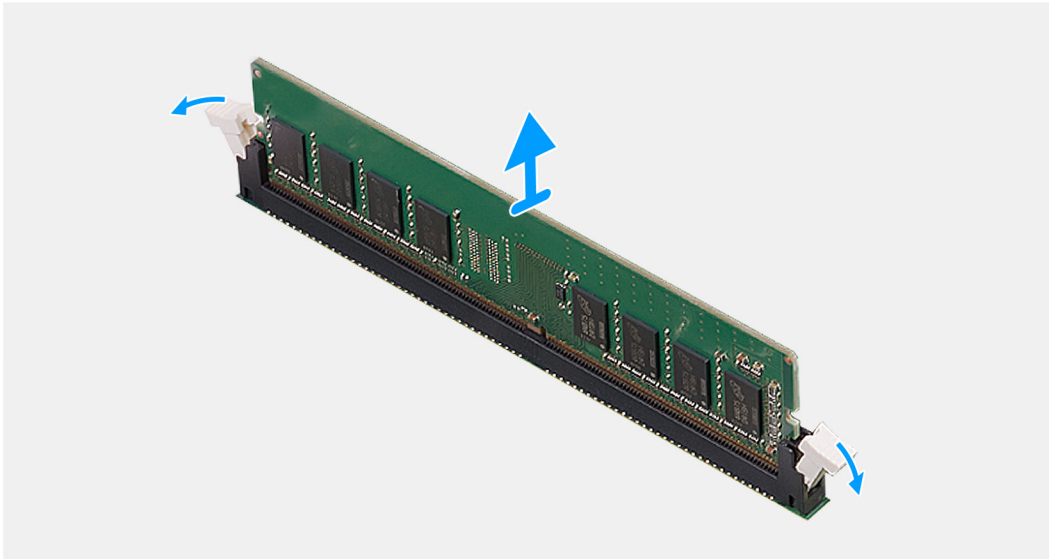
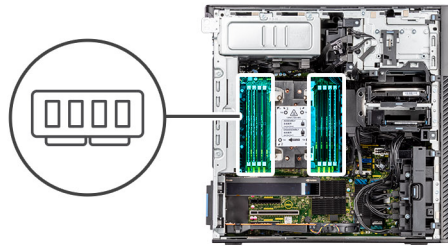

### Steps

1. Pull the securing clips from both side of the memory module until the memory module pops up.
2. Slide and remove the memory module from the memory-module slot.

## Installing the memory module

### Prerequisites

If you are replacing a component, remove the existing component before performing the installation procedure.

### About this task

The following image indicates the location of the memory module and provides a visual representation of the installation procedure.

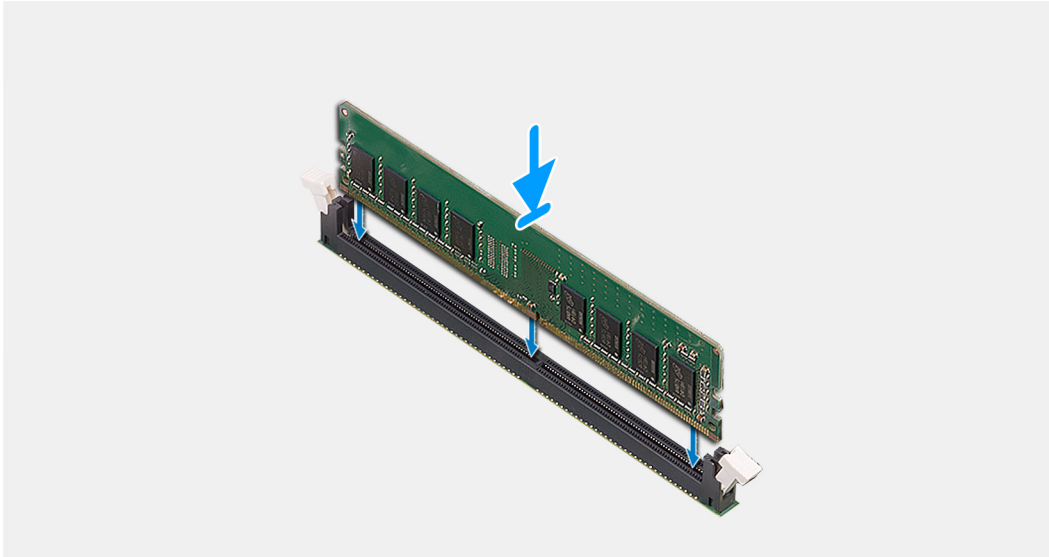
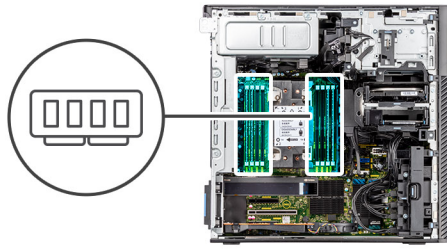

### Steps

1. Align the notch on the memory module with the tab on the memory-module slot.
2. Slide the memory module firmly into the slot at an angle and press the memory module down until it clicks into place.

**NOTE:** If you do not hear the click, remove the memory module and reinstall it.

### Next steps

1. Install the [air shroud](#).
2. Install the [side cover](#).
3. Follow the procedure in [after working inside your computer](#).

## M.2 solid-state drive

### Removing the M.2 2230 PCIe solid-state drive

#### Prerequisites

1. Follow the procedure in [Before working inside your computer](#).
2. Remove the [side cover](#).
3. Remove the [PCIe holder](#).

#### About this task

The following images indicate the location of the M.2 2230 solid-state drive and provide a visual representation of the removal procedure.



**2x**  
M2 x 3.5

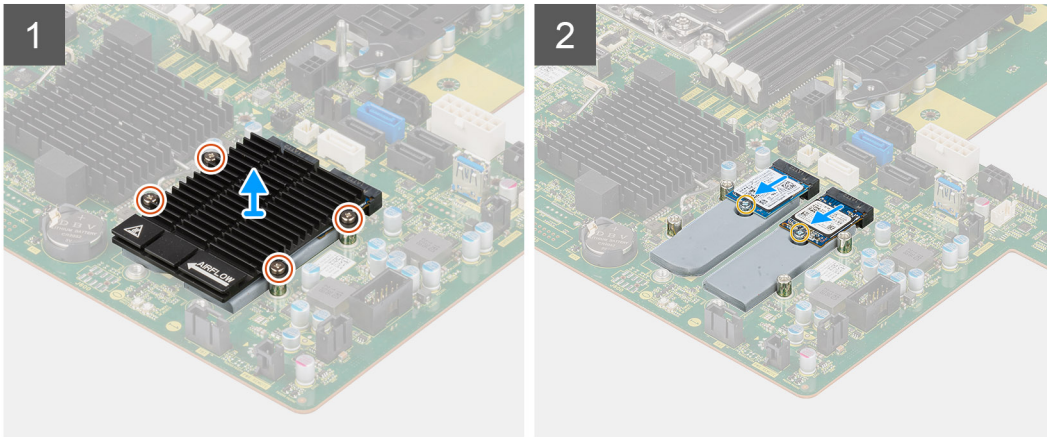

### Steps

1. Loosen the four captive screws that secures the M.2 heat-sink to the system board.
2. Lift and remove the M.2 heat-sink from the computer.
3. Remove the single (M2x3.5) screw that secures the solid-state drive to the system board.
4. Slide and lift the solid-state drive off the system board.

**i** **NOTE:** If the computer has two solid-state drives installed, repeat Steps 3-4 for the second solid-state drive.

## Installing the M.2 2230 PCIe solid-state drive

### Prerequisites

If you are replacing a component, remove the existing component before performing the installation procedure.

### About this task

The following images indicate the location of the M.2 2230 solid-state drive and provides a visual representation of the installation procedure.



**2x**  
M2 x 3.5

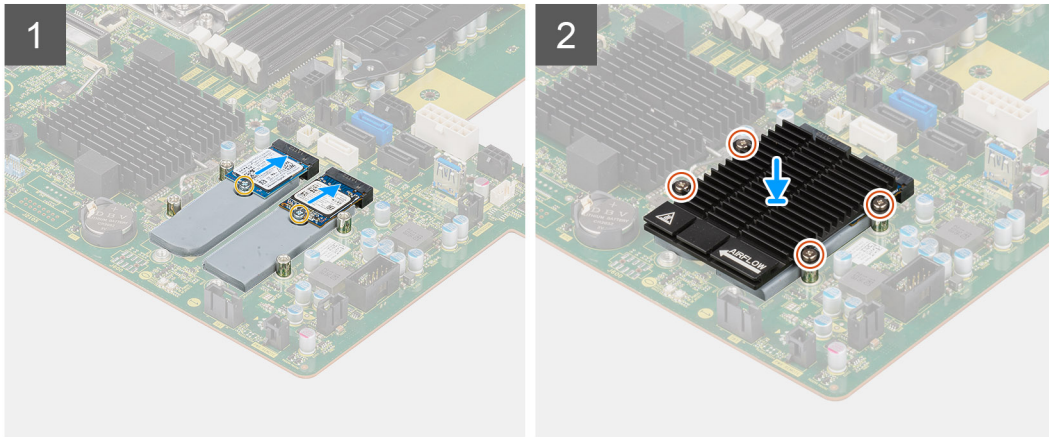

### Steps

1. Align the notch on the solid-state drive with the tab on the solid-state drive connector.
2. Insert the solid-state drive at a 45-degree angle into the slot on the system board.

**i** **NOTE:** When replacing a M.2 2280 solid-state drive from a M.2 2230 solid-state drive, ensure to move the standoff nut to the M.2 2230 solid-state drive slot position.

3. Replace the single (M2x3.5) screw to secure the solid-state drive to the system board.

**i** **NOTE:** If the computer has two solid-state drives installed, repeat Steps 2-3 for the second solid-state drive.

4. Align and place the M.2 heat-sink over the solid-state drive.
5. Tighten the four captive screws to secure the M.2 heat-sink to the system board.

### Next steps

1. Install the [PCIe holder](#).
2. Install the [side cover](#).
3. Follow the procedure in [After working inside your computer](#).

## Removing the M.2 2280 PCIe solid-state drive

### Prerequisites

1. Follow the procedure in [Before working inside your computer](#).
2. Remove the [side cover](#).
3. Remove the [PCIe holder](#).

### About this task

The following images indicate the location of the M.2 2280 solid-state drive and provide a visual representation of the removal procedure.



**2x**  
M2 x 3.5

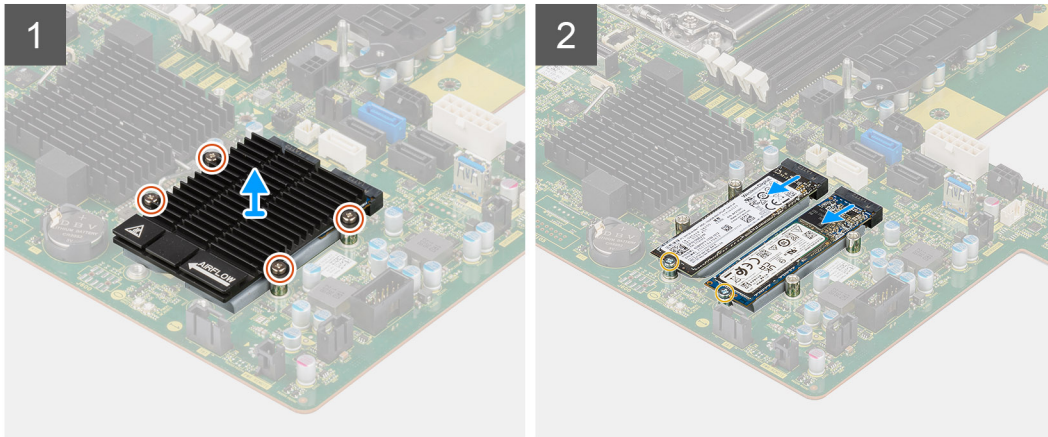

### Steps

1. Loosen the four captive screws that secure the M.2 heat-sink to the system board.
2. Lift and remove the M.2 heat-sink from the computer.
3. Remove the single (M2x3.5) screw that secures the solid-state drive to the system board.
4. Slide and lift the solid-state drive off the system board.

**NOTE:** If the computer has two solid-state drives installed, repeat Steps 3-4 for the second solid-state drive.

## Installing the M.2 2280 PCIe solid-state drive

### Prerequisites

If you are replacing a component, remove the existing component before performing the installation procedure.

### About this task

The following images indicate the location of the M.2 2280 solid-state drive and provides a visual representation of the installation procedure.



**2x**  
M2 x 3.5

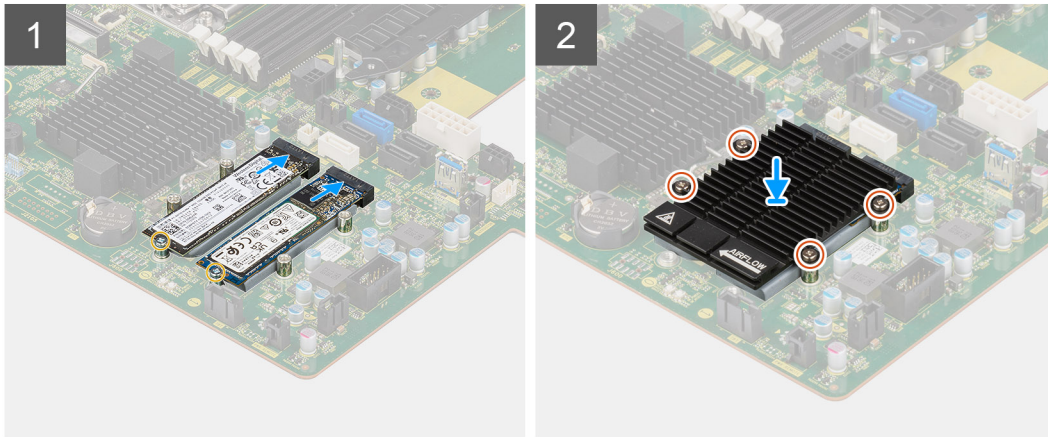

### Steps

1. Align the notch on the solid-state drive with the tab on the solid-state drive connector.
2. Insert the solid-state drive at a 45-degree angle into the slot on the system board.

**i** **NOTE:** When replacing a M.2 2280 solid-state drive to a M.2 2230 solid-state drive, ensure to move the standoff nut to the M.2 2230 solid-state drive slot position.

3. Replace the single (M2x3.5) screw to secure the solid-state drive to the system board.

**i** **NOTE:** If the computer has two solid-state drives installed, repeat Steps 2-3 for the second solid-state drive.

4. Align and place the M.2 heat-sink over the solid-state drive.
5. Tighten the four captive screws to secure the M.2 heat-sink to the system board.

### Next steps

1. Install the [PCIe holder](#).
2. Install the [side cover](#).
3. Follow the procedure in [After working inside your computer](#).

## Heat sink

### Removing the heat-sink assembly

#### Prerequisites

1. Follow the procedure in [Before working inside your computer](#).

**!** **WARNING:** The heat sink may become hot during normal operation. Allow sufficient time for the heat sink to cool before you touch it.

**!** **CAUTION:** For maximum cooling of the processor, do not touch the heat transfer areas on the heat sink. The oils in your skin can reduce the heat transfer capability of the thermal grease.

2. Remove the [side cover](#).
3. Remove the [air shroud](#).

### About this task

The following images indicate the location of the heat-sink assembly and provide a visual representation of the removal procedure.

The image of the heat-sink assembly may vary depending on the configuration ordered.



4x

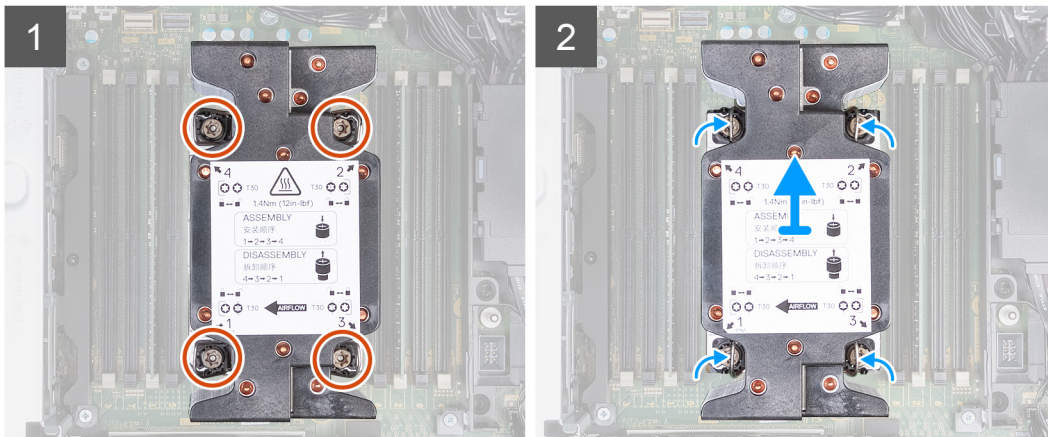
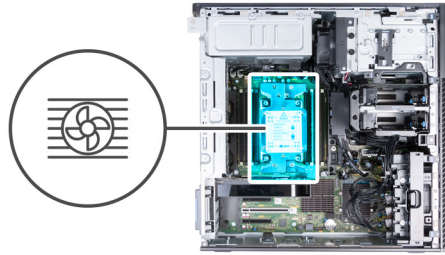

### Steps

1. Using a Torx T30screwdriver, in reverse sequential order (4->3->2->1), loosen the four captive screws that secure the heat-sink assembly to the system board.

**NOTE:** The numbering and order in which to loosen the screws is printed on the heat-sink assembly.

2. Push the four retaining clips inwards to unlock the heat-sink assembly from the system board.

## Installing the heat-sink assembly

### Prerequisites

If you are replacing a component, remove the existing component before performing the installation procedure.

**NOTE:** Refer to the instructions provided with the kit for steps on how to apply the thermal grease.

### About this task

The following images indicate the location of the heat-sink assembly and provides a visual representation of the installation procedure.

The image of the heat-sink assembly may vary depending on the configuration ordered.



4x

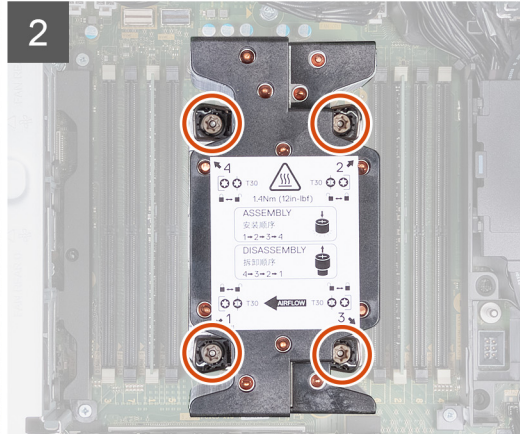
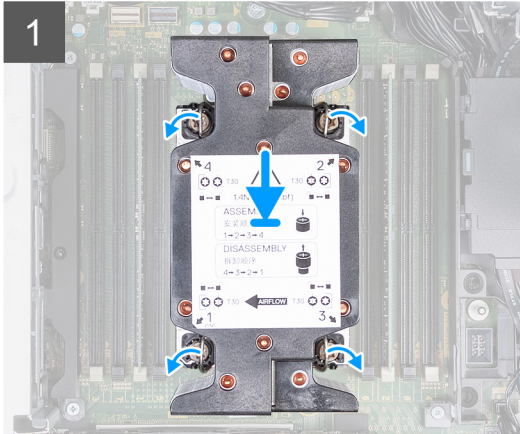

### Steps

1. Align the screws on the processor fan and heat-sink assembly with the screw holders on the system board and place the processor fan and heat-sink assembly on the processor.
2. In sequential order (1->2->3->4), tighten the captive screws to secure the processor fan and heat-sink assembly to the system board.

**i** **NOTE:** The numbering and order in which to tighten the screws is printed on the heat-sink assembly.

### Next steps

1. Install the [air shroud](#).
2. Install the [side cover](#).
3. Follow the procedure in [After working inside your computer](#).

## Processor

### Removing the processor

#### Prerequisites

1. Follow the procedure in [Before working inside your computer](#).
2. Remove the [side cover](#).
3. Remove the [heat-sink assembly](#).

**i** **NOTE:** The processor might still be hot after the computer is shut down. Allow the processor to cool down before removing it.

#### About this task

The following images indicate the location of the processor and provide a visual representation of the removal procedure.

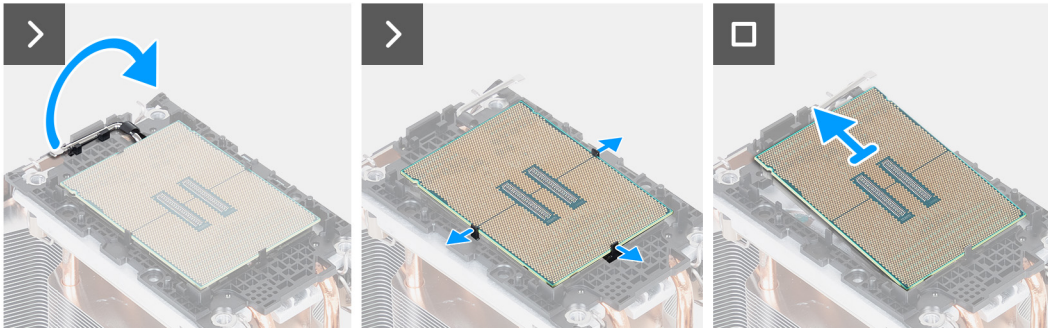
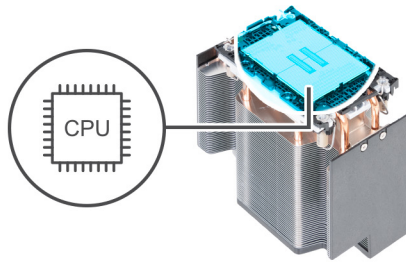

**Steps**

1. Slide outwards and release the lever from the securing clips on the CPU carrier.
2. Pull the securing clips on the CPU carrier and release the processor.
3. Gently slide the processor out of the CPU carrier.

## Installing the processor

**Prerequisites**

If you are replacing a component, remove the existing component before performing the installation procedure.

**About this task**

The following images indicate the location of the processor and provides a visual representation of the installation procedure.

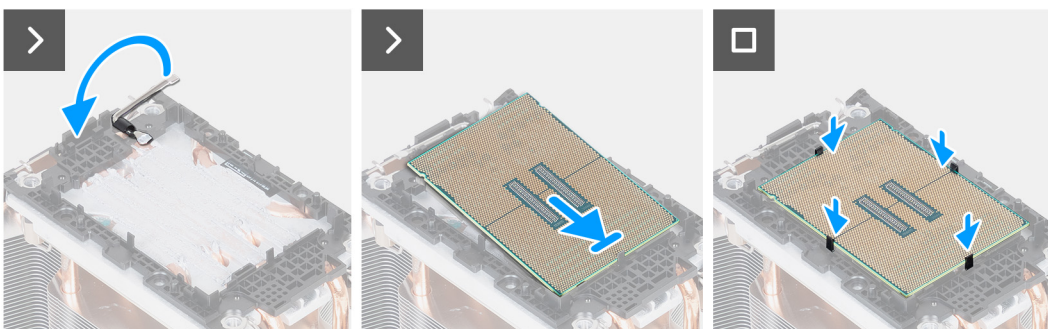
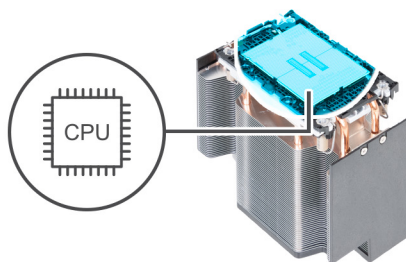

**Steps**

1. Close and lock the lever with the securing clips on the CPU carrier.

2. At an angle, slide the processor on the CPU carrier.
3. Push the processor gently and lock the processor to the securing clips on the CPU carrier.

#### **Next steps**

1. Install the [heat-sink assembly](#).
2. Install the [side cover](#).
3. Follow the procedure in [After working inside your computer](#).

## **Expansion card**

### **Removing the powered graphics-card**

#### **Prerequisites**

1. Follow the procedure in [Before working inside your computer](#).
2. Remove the [side cover](#).
3. Remove the [air shroud](#).

#### **About this task**

The following images indicate the location of the powered graphics-card and provide a visual representation of the removal procedure.

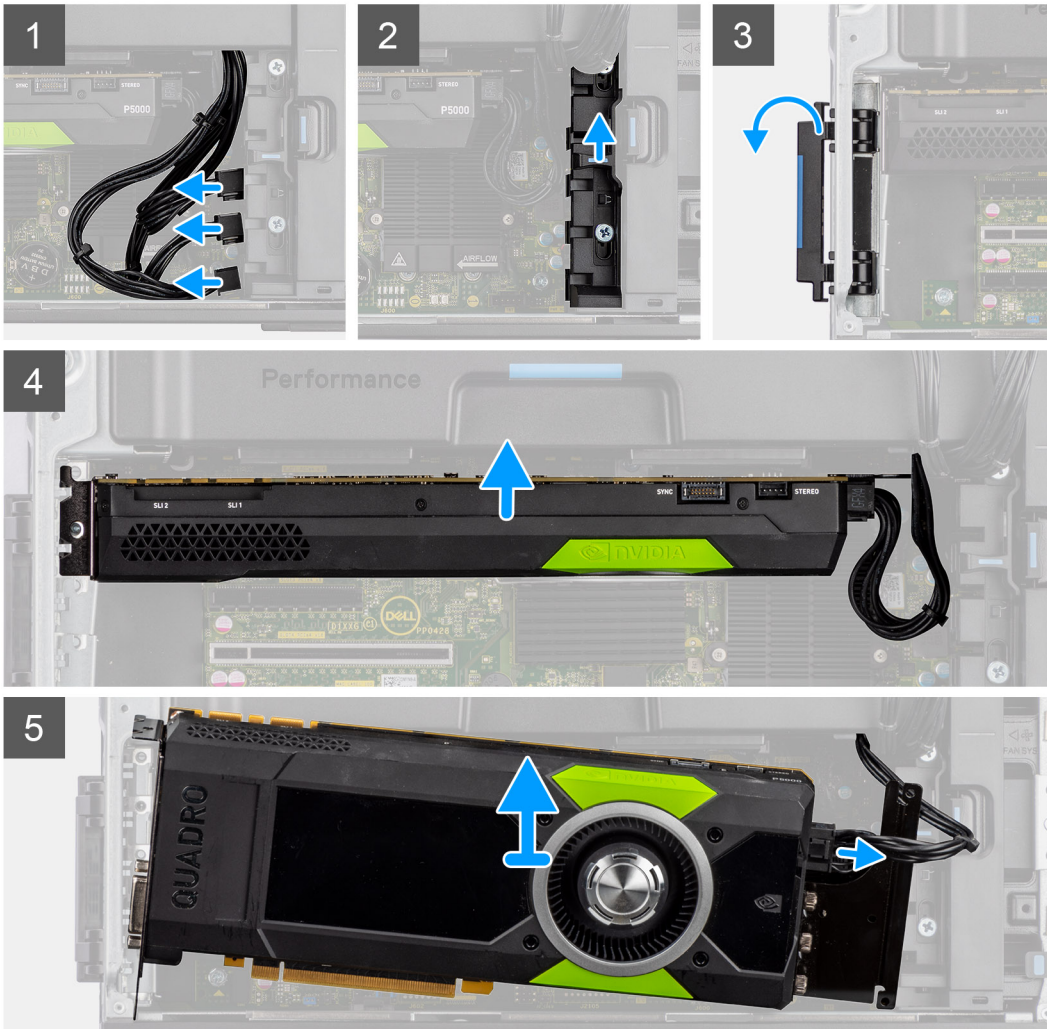

### Steps

1. Disconnect the PCIe-power cable from the connector on the graphics card.
2. Remove the PCIe-power cables from the PCIe holder.
3. Push the PCIe latch to open the PCIe door.
4. Push the PCIe-holder latch upwards to release the PCIe-card bracket.
5. Lift the graphics card away from the graphics-card slot.

## Installing the powered graphics-card

### Prerequisites

If you are replacing a component, remove the existing component before performing the installation procedure.

## About this task

The following images indicate the location of the powered graphics-card and provide a visual representation of the installation procedure.

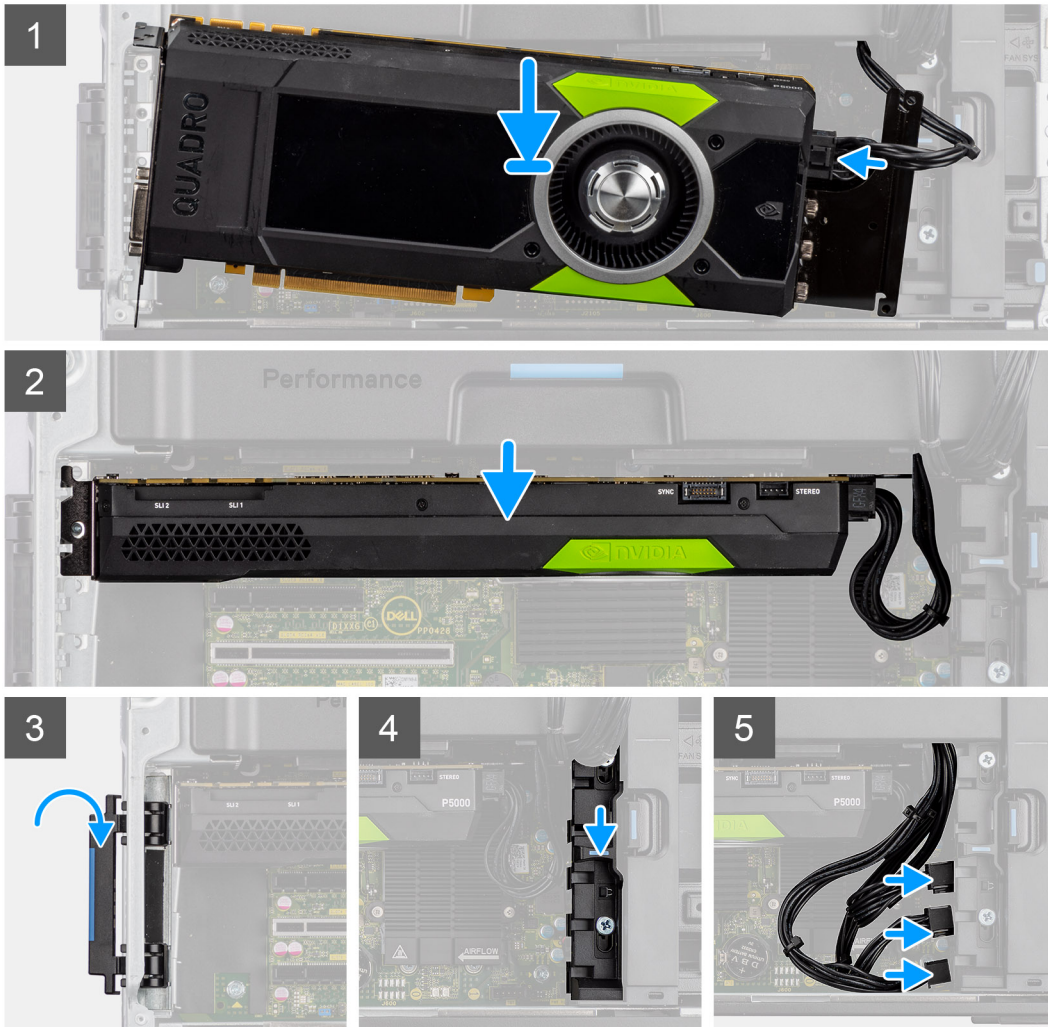

## Steps

1. Align the powered graphics card with the PCIe slot on the system board.
2. Using the alignment post, push the graphic card connector firmly into the PCIe slot. Ensure that the graphics card is firmly seated.
3. Slide the release latch down on the PCIe-holder to secure the PCIe-card bracket.
4. Connect the PCIe-power cable to the connectors on the graphics card.
5. Connect the PCIe-power cables to the slots on the PCIe holder.

## Next steps

1. Install the [air shroud](#).
2. Install the [side cover](#).

3. Follow the procedure in [After working inside your computer](#).

## Removing the non-powered graphics card

### Prerequisites

1. Follow the procedure in [Before working inside your computer](#).
2. Remove the [side cover](#).
3. Remove the [air shroud](#).

### About this task

The following images indicate the location of the non-powered graphics card and provide a visual representation of the removal procedure.

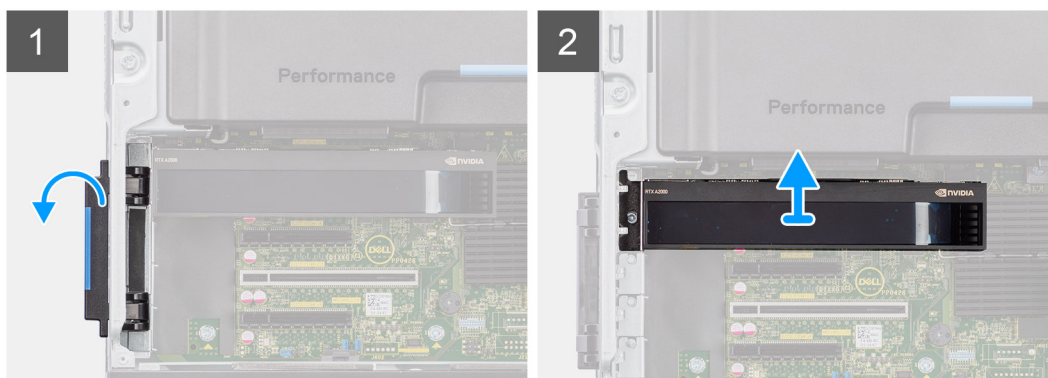

### Steps

1. Push the PCIe latch to open the PCIe door.
2. Lift the graphics card away from the graphics-card slot.

## Installing the non-powered graphics card

### Prerequisites

If you are replacing a component, remove the existing component before performing the installation procedure.

### About this task

The following images indicate the location of the non-powered graphics card and provide a visual representation of the installation procedure.

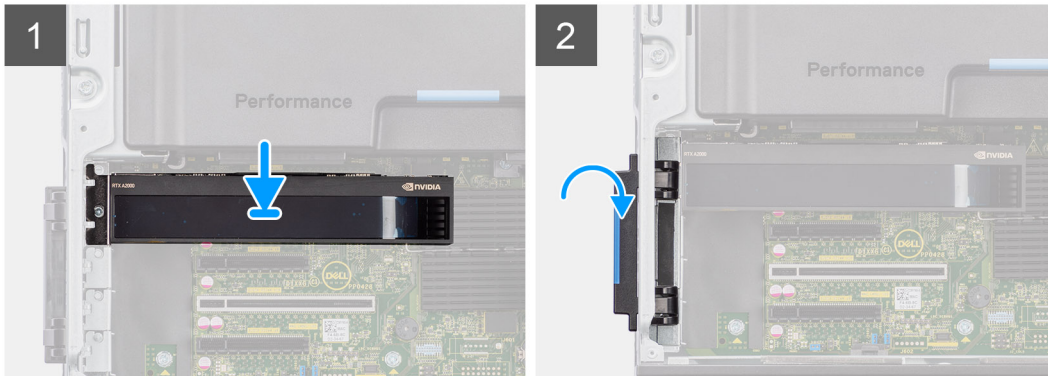

### Steps

1. Align the graphics card with the PCIe slot on the system board.
2. Using the alignment post, push the graphic card connector firmly into the PCIe slot. Ensure that the graphics card is firmly seated.
3. Close the PCIe door, locking it into position.

### Next steps

1. Install the [air shroud](#).
2. Install the [side cover](#).
3. Follow the procedure in [After working inside your computer](#).

## Removing the UltraSpeed Duo card

### Prerequisites

1. Follow the procedure in [Before working inside your computer](#).
2. Remove the [side cover](#).
3. Remove the [air shroud](#).

### About this task

The following images indicate the location of the UltraSpeed Duo card and provide a visual representation of the removal procedure.

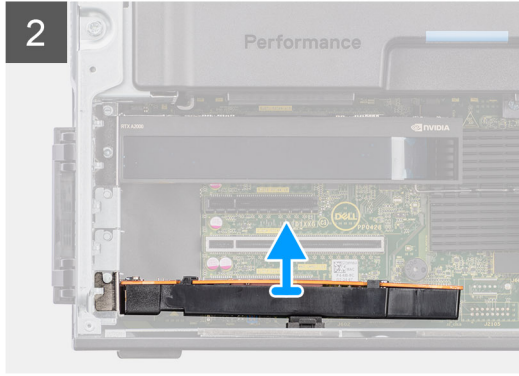
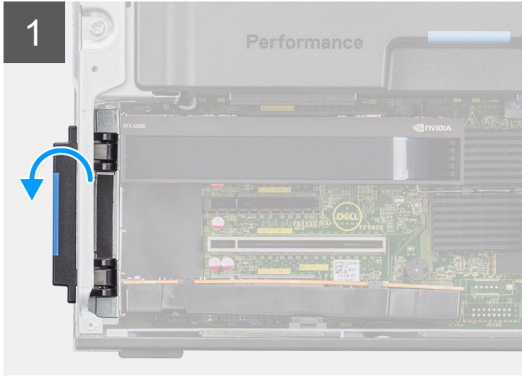

### Steps

1. Push the PCIe latch to open the PCIe door.
2. Lift and remove the UltraSpeed Duo card away from the expansion-card slot.

## Installing the UltraSpeed Duo card

### Prerequisites

If you are replacing a component, remove the existing component before performing the installation procedure.

### About this task

The following images indicate the location of the UltraSpeed Duo card and provide a visual representation of the installation procedure.

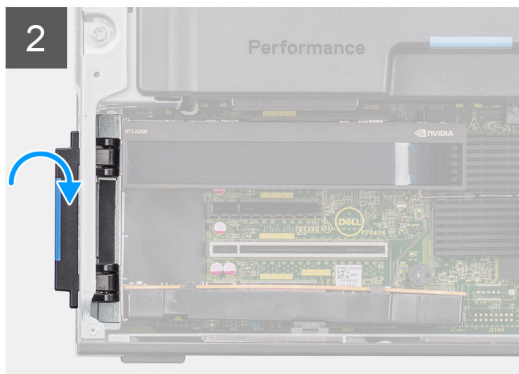
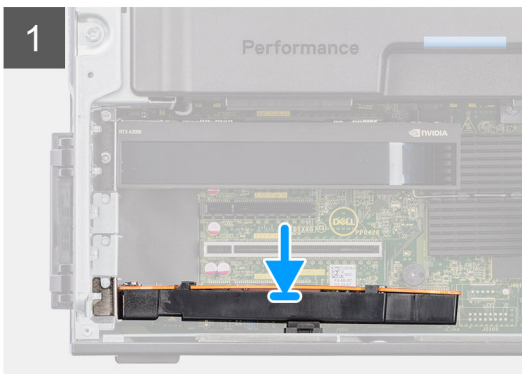

### Steps

1. Align the UltraSpeed Duo card with the expansion-card slot on the system board.
2. Using the alignment post, connect the UltraSpeed Duo card to the connector and press down firmly. Ensure that the UltraSpeed Duo card is firmly seated.
3. Close the PCIe door, locking it into position.

### Next steps

1. Install the [air shroud](#).
2. Install the [side cover](#).
3. Follow the procedure in [After working inside your computer](#).

## Removing the UltraSpeed Quad card

### Prerequisites

1. Follow the procedure in [Before working inside your computer](#).
2. Remove the [side cover](#).
3. Remove the [air shroud](#).

### About this task

The following images indicate the location of the UltraSpeed Quad card and provide a visual representation of the removal procedure.

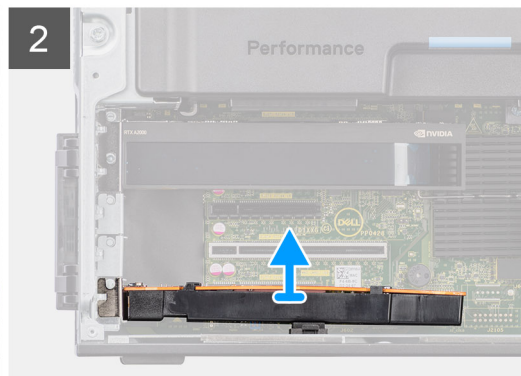
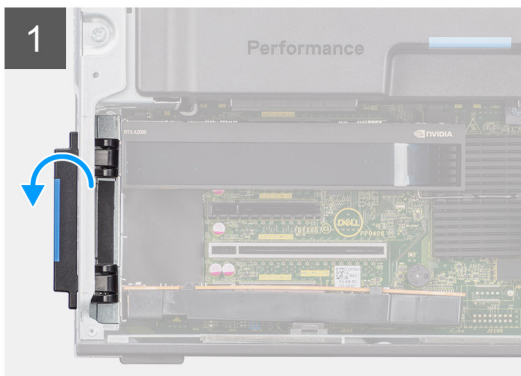

### Steps

1. Push the PCIe latch to open the PCIe door.
2. Lift and remove the UltraSpeed Quad card away from the expansion-card slot.

## Installing the UltraSpeed Quad card

### Prerequisites

If you are replacing a component, remove the existing component before performing the installation procedure.

### About this task

The following images indicate the location of the UltraSpeed Quad card and provide a visual representation of the installation procedure.

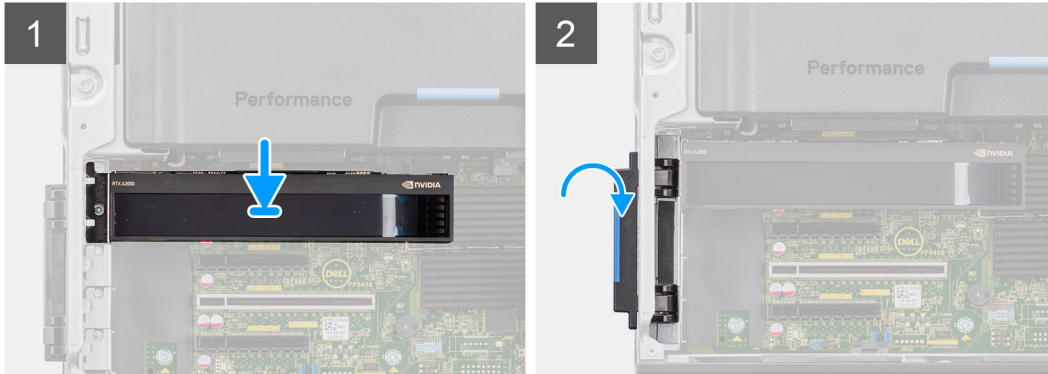

### Steps

1. Align the UltraSpeed Quad card with the expansion-card slot on the system board.
2. Using the alignment post, connect the UltraSpeed Quad card to the connector and press down firmly. Ensure that the UltraSpeed Quad card is firmly seated.
3. Close the PCIe door, locking it into position.

### Next steps

1. Install the [air shroud](#).
2. Install the [side cover](#).
3. Follow the procedure in [After working inside your computer](#).

## Removing the Thunderbolt PCIe card

### Prerequisites

1. Follow the procedure in [Before working inside your computer](#).
2. Remove the [side cover](#).
3. Remove the [air shroud](#).

### About this task

The following images indicate the location of the Thunderbolt PCIe card and provide a visual representation of the removal procedure.

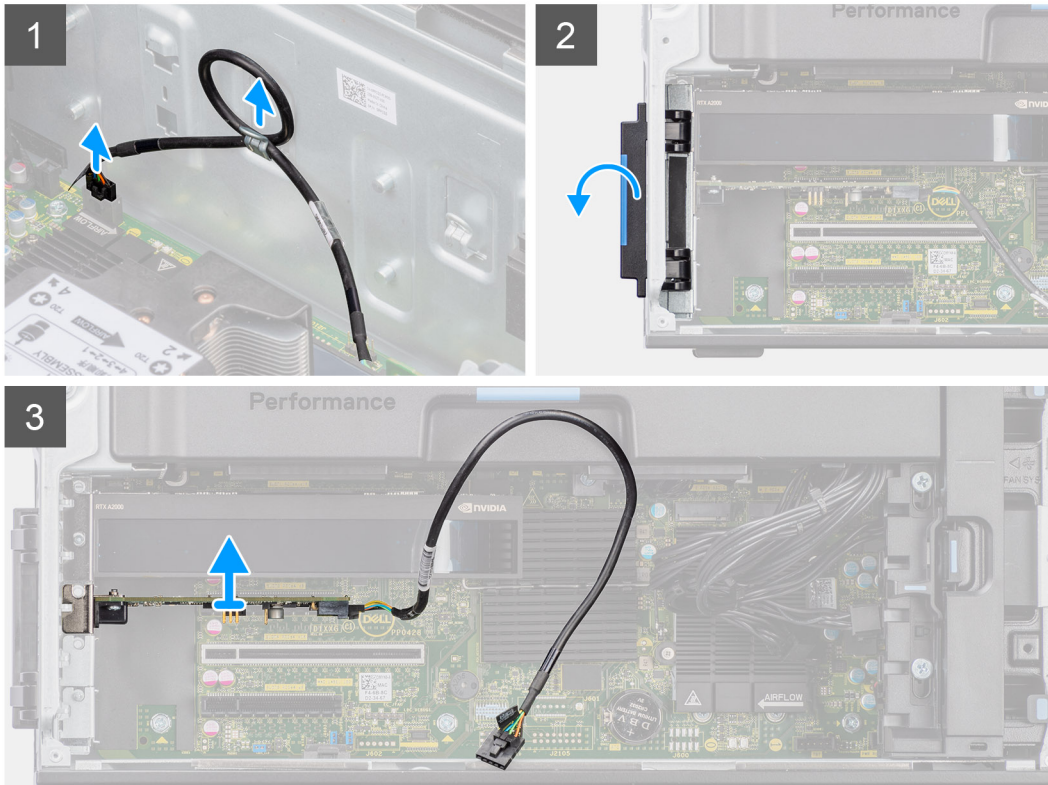

### Steps

1. Disconnect the Thunderbolt PCIe cable from the connector on the system.
2. Remove the Thunderbolt PCIe cable from the routing guide on the chassis.
3. Push the PCIe latch to open the PCIe door.
4. Lift and remove the Thunderbolt PCIe card away from the expansion-card slot.

## Installing the Thunderbolt PCIe card

### Prerequisites

If you are replacing a component, remove the existing component before performing the installation procedure.

### About this task

The following images indicate the location of the Thunderbolt PCIe card and provide a visual representation of the installation procedure.

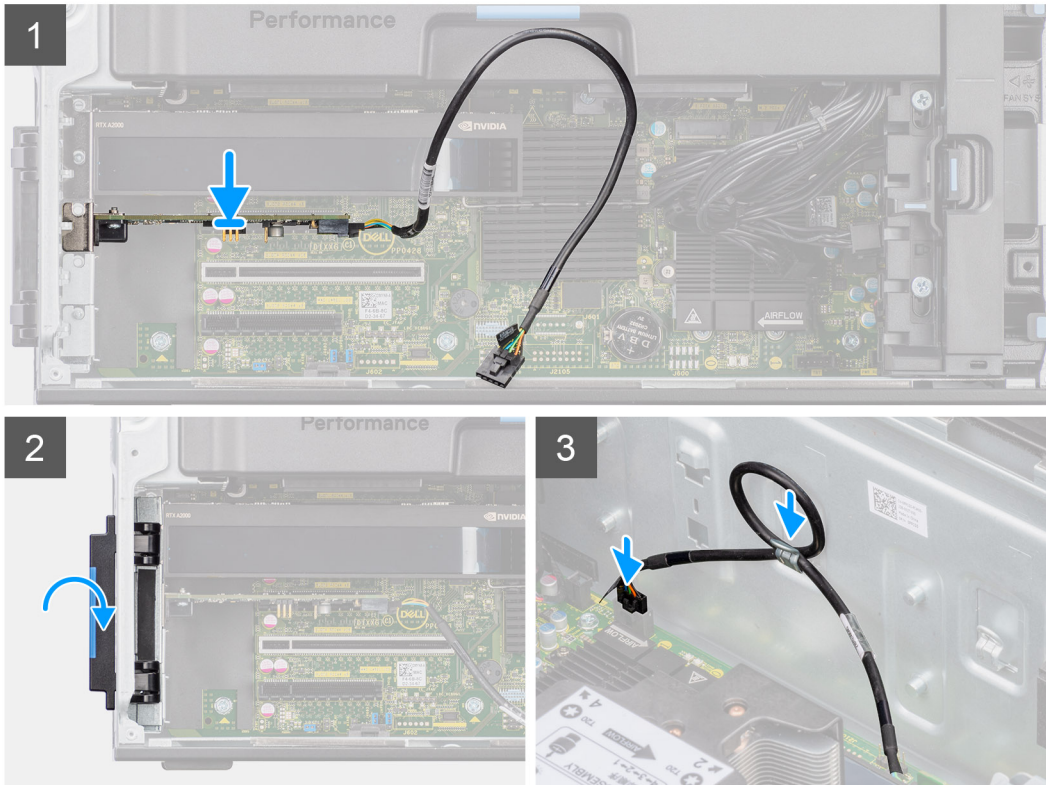

### Steps

1. Align the Thunderbolt PCIe card with the expansion-card slot on the system board.
2. Using the alignment post, connect the Thunderbolt PCIe card to the connector and press down firmly. Ensure that the Thunderbolt PCIe card is firmly seated.
3. Route the Thunderbolt PCIe through the routing guide on the chassis.
4. Connect the Thunderbolt PCIe cable to the connector on the system board.
5. Close the PCIe door, locking it into position.

### Next steps

1. Install the [air shroud](#).
2. Install the [side cover](#).
3. Follow the procedure in [After working inside your computer](#).

## Removing the wireless card

### Prerequisites

1. Follow the procedure in [Before working inside your computer](#).
2. Remove the [side cover](#).
3. Remove the [air shroud](#).

**About this task**

The following images indicate the location of the wireless card and provide a visual representation of the removal procedure.

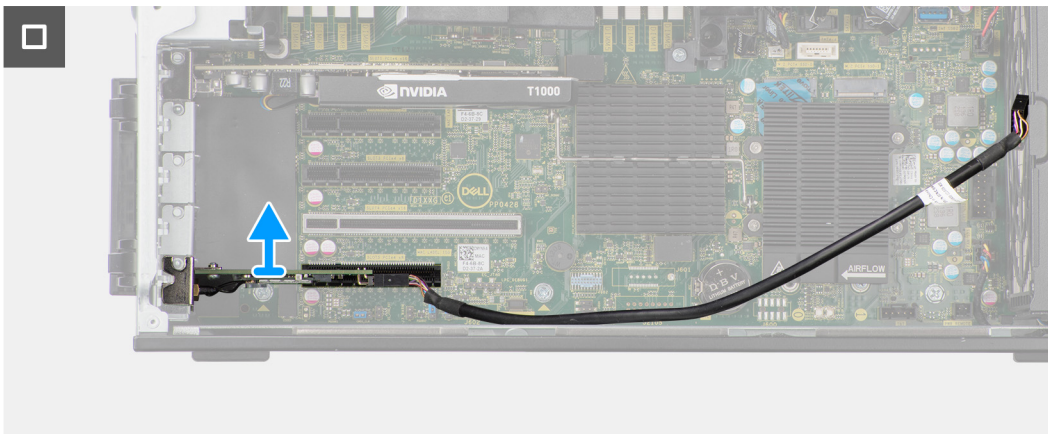
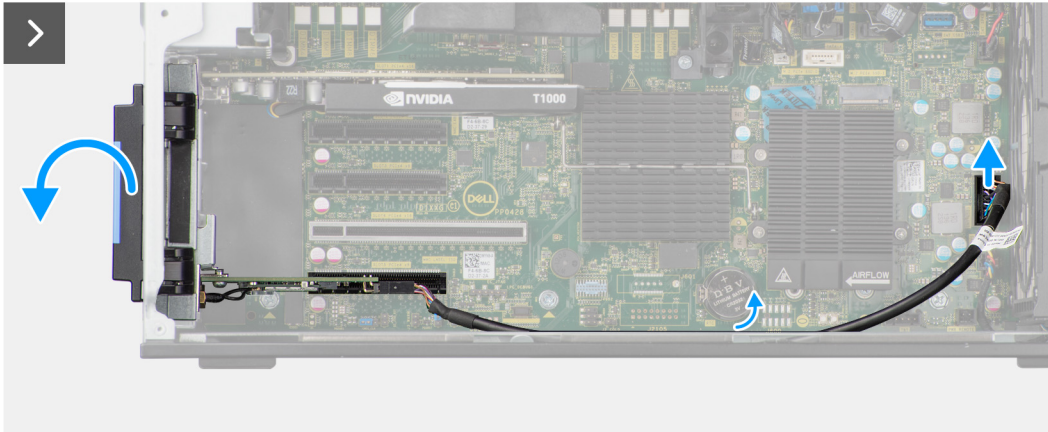
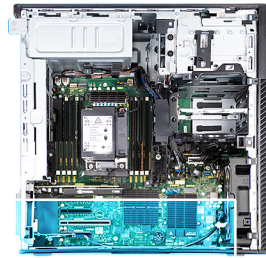



1x  
M2x3

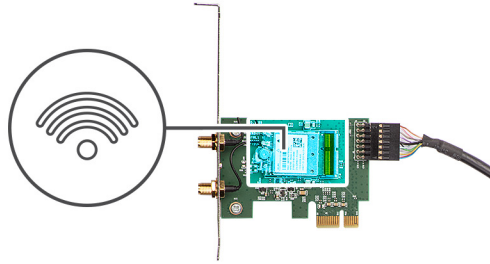

### Steps

1. Loosen the captive screw on the external-antenna cover.
2. Remove the external-antenna cover from over the antenna connectors on the PCIe-riser card.
3. Loosen the bolts on the external-antenna cable connector.
4. Disconnect the PCIe-riser card cable from the connector on the system board.
5. Remove the PCIe-riser card cable from the routing guide on the chassis.
6. Push the PCIe latch to open the PCIe door.
7. Remove the PCIe-riser card from the expansion-card slot.
8. Remove the single (M2x3) screw from the WLAN card.
9. Disconnect the WLAN antenna cables from the connectors on the WLAN card.
10. Slide and remove the WLAN card from the WLAN slot on the PCIe-riser card.

## Installing the wireless card

### Prerequisites

If you are replacing a component, remove the existing component before performing the installation procedure.

### About this task

The following images indicate the location of the wireless card and provide a visual representation of the installation procedure.



1x  
M2x3

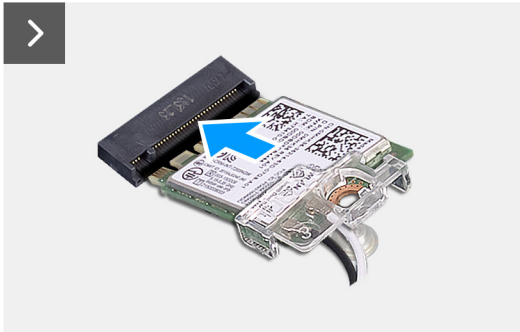
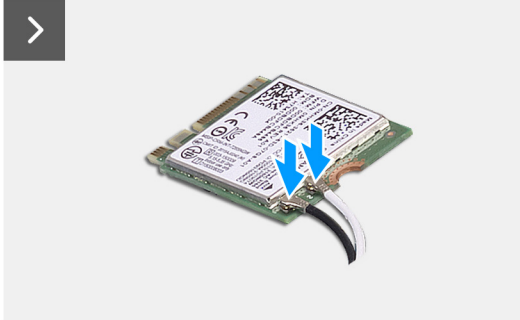
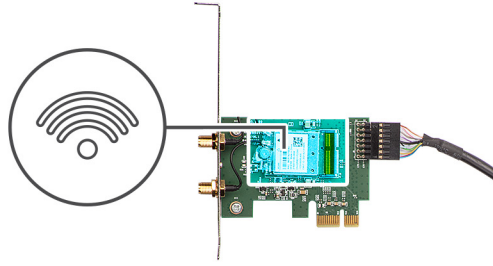

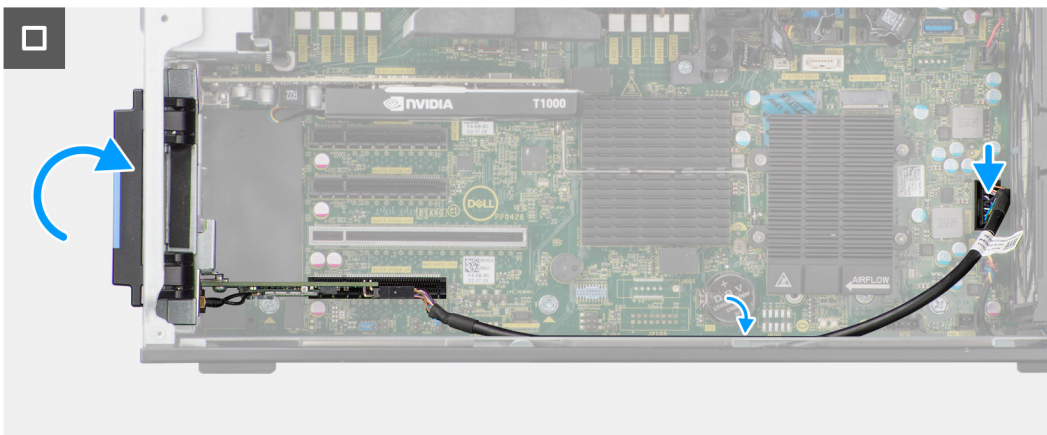
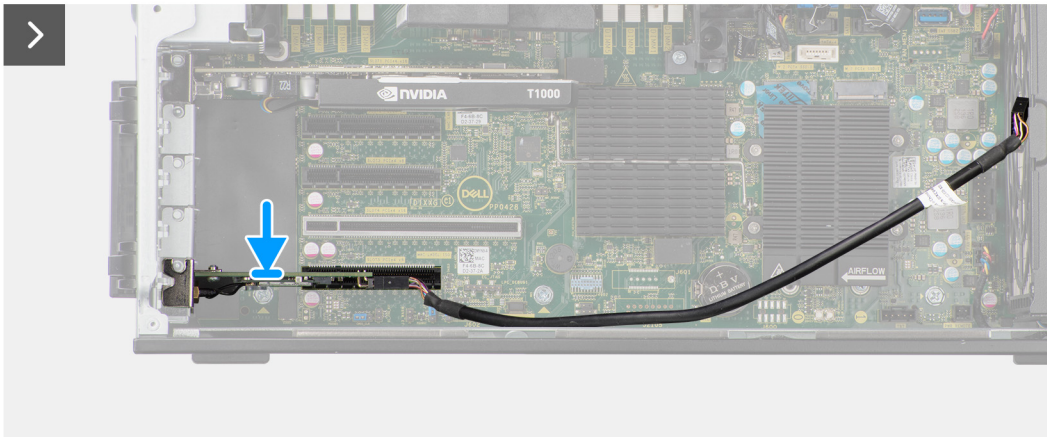
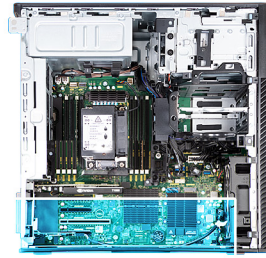

### Steps

1. Align the notch on the WLAN card with the tab on the PCIe riser-card.
2. Slide the WLAN card at an angle into the PCIe riser-card.
3. Install the single (M2x3) screw to secure the WLAN card to the PCIe-riser card.
4. Align and slide the PCIe riser card into the expansion-card slot on the system board.
5. Connect the PCIe riser-card cable to the connector on system board.
6. Route the PCIe riser-card cable through the hook on the chassis.
7. Tighten the bolts to secure the external-antenna cable to the connector on the PCIe riser-card.
8. Push the external-antenna cover towards the chassis to secure the external-antenna cable.
9. Replace the single screw that secures the external-antenna cover to the PCIe riser-card and chassis.

### Next steps

1. Install the [air shroud](#).
2. Install the [side cover](#).
3. Follow the procedure in [After working inside your computer](#).

# Speaker

## Removing the speaker

### Prerequisites

1. Follow the procedure in [Before working inside your computer](#).
2. Remove the [side cover](#).
3. Remove the [front bezel](#).
4. Remove the [air shroud](#).

### About this task

The following images indicate the location of the speaker and provide a visual representation of the removal procedure.

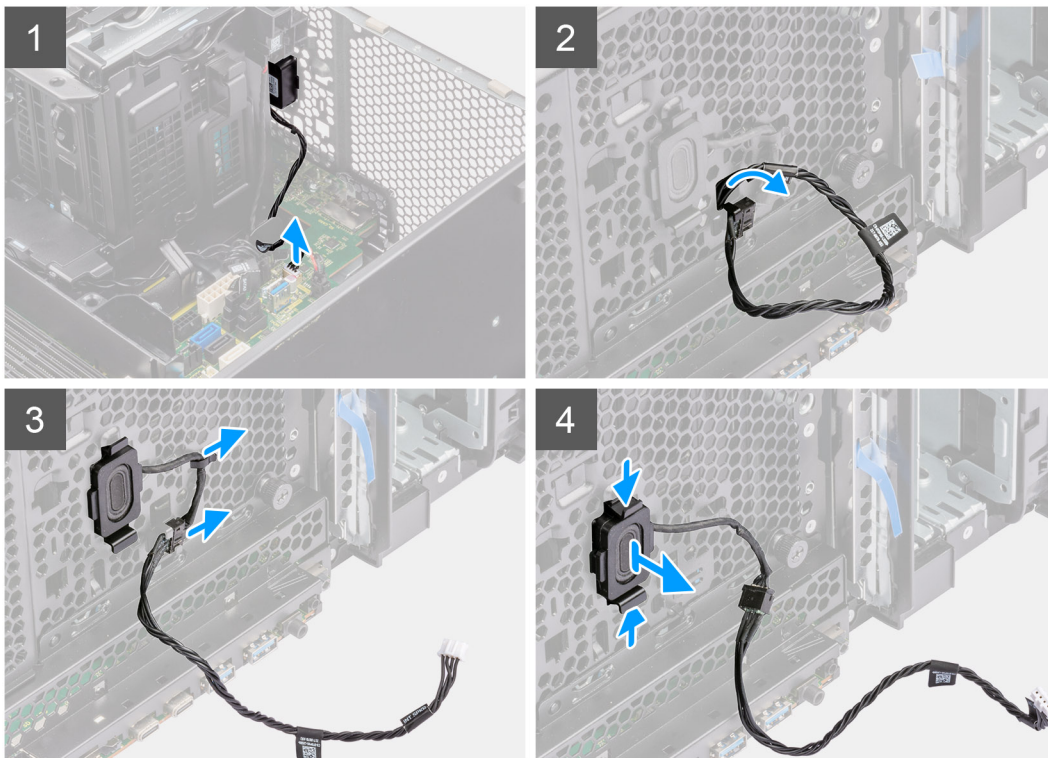

### Steps

1. Disconnect the speaker cable from the connector on the system board.
2. Remove the speaker cable from the front chassis.
3. Remove the speaker cable from the routing guides on the chassis.
4. Press the two tabs and pull the speaker along with the cable from the slot on the chassis.

## Installing the speaker

### Prerequisites

If you are replacing a component, remove the existing component before performing the installation procedure.

### About this task

The following image indicates the location of the speaker and provides a visual representation of the installation procedure.

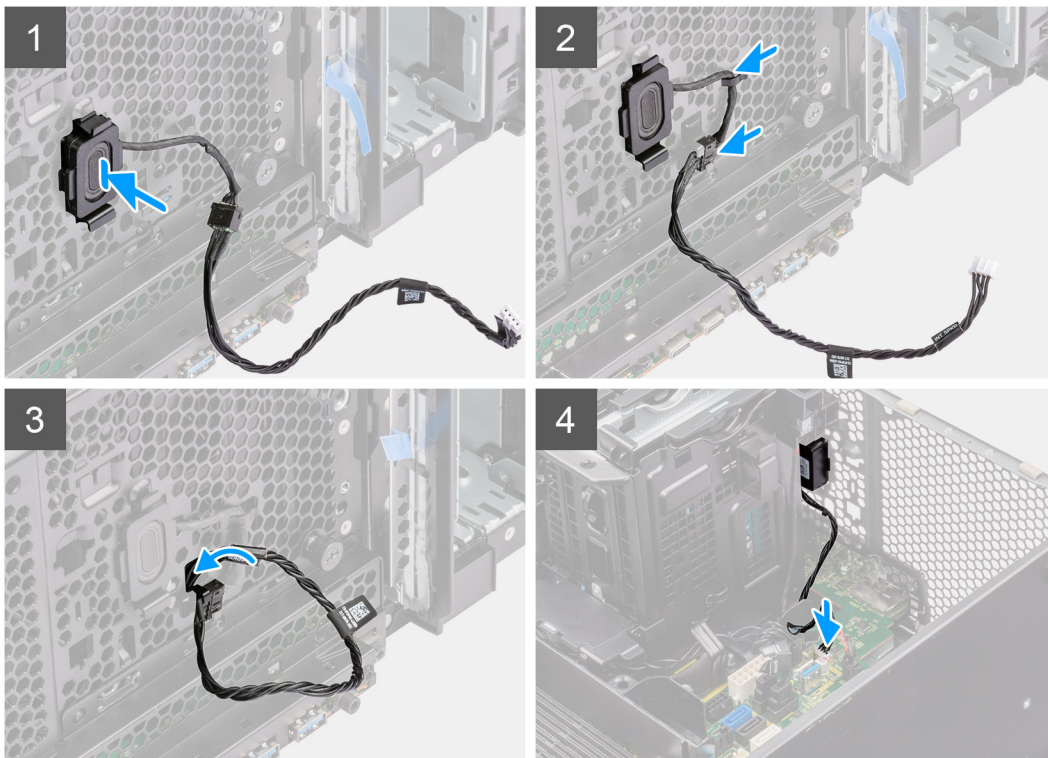

### Steps

1. Press the tabs on the speaker and push the speaker in to the slot on the chassis until it snaps into place.
2. Route the speaker cable through the routing guide on the chassis.
3. Route the speaker cable through the slot on the chassis.
4. Connect the speaker cable to the connector on the system board.

### Next steps

1. Install the [air shroud](#).
2. Install the [front bezel](#).
3. Install the [side cover](#).
4. Follow the procedure in [After working inside your computer](#).

## Intrusion switch

### Removing the intrusion switch

#### Prerequisites

1. Follow the procedure in [Before working inside your computer](#).
2. Remove the [side cover](#).
3. Remove the [air shroud](#).

#### About this task

The following images indicate the location of the intrusion switch and provide a visual representation of the removal procedure.



1x  
M3

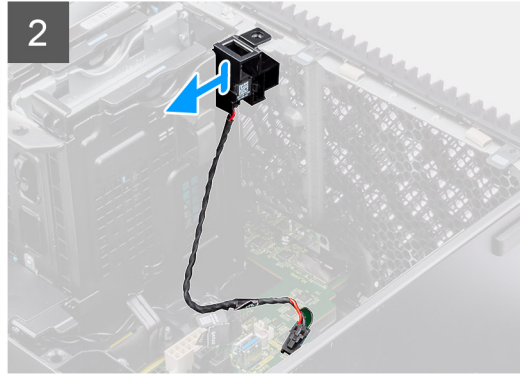
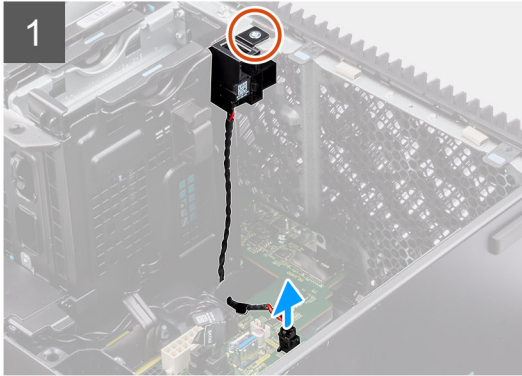
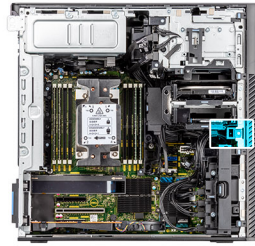

### Steps

1. Disconnect the intrusion-switch cable from the connector on the system board.
2. Remove the cable from the routing point on the system board.
3. Remove the single (M3) screw to remove the intrusion switch and cable from the computer.

## Installing the intrusion switch

### Prerequisites

If you are replacing a component, remove the existing component before performing the installation procedure.

### About this task

The following images indicate the location of the intrusion switch and provide a visual representation of the installation procedure.



1x  
M3

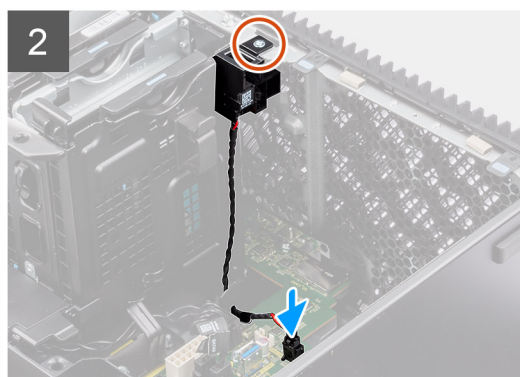
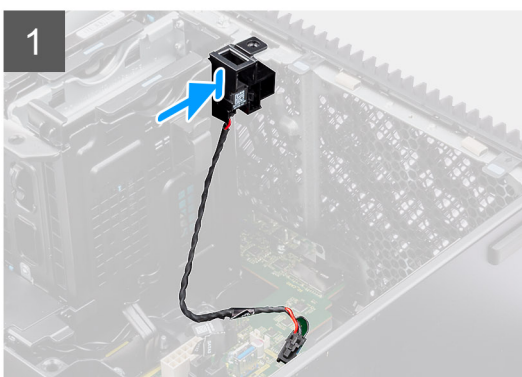
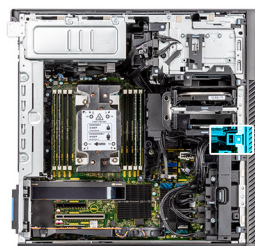

## Steps

1. Insert the intrusion switch into its slot in the chassis and secure it into place with the single (M3) screw.
2. Route the intruder cable through the routing guides on the system board.
3. Connect the intrusion-switch cable to the connector on the system board.

## Next steps

1. Install the [air shroud](#).
2. Install the [side cover](#).
3. Follow the procedure in [After working inside your computer](#).

# Voltage-regulator heat sink

## Removing the voltage-regulator heat sink - Location 1

### Prerequisites

1. Follow the procedure in [Before working inside your computer](#).

 **WARNING:** The heat sink may become hot during normal operation. Allow sufficient time for the heat sink to cool before you touch it.

 **CAUTION:** For maximum cooling of the processor, do not touch the heat transfer areas on the heat sink. The oils in your skin can reduce the heat transfer capability of the thermal grease.

2. Remove the [side cover](#).
3. remove the [air shroud](#).

### About this task

The following image indicates the location of the voltage-regulator heat sink and provides a visual representation of the removal procedure.



2x  
M3x5

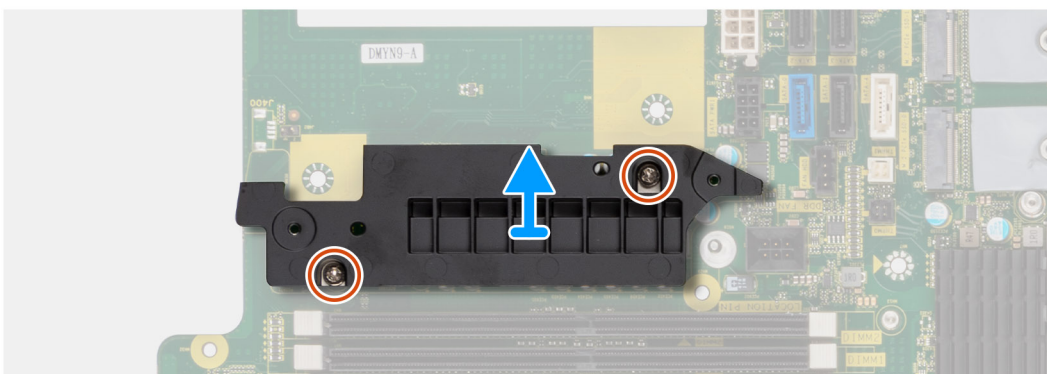
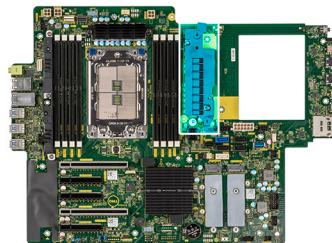

## Steps

1. Remove the two (M3x5) screws that secure the voltage-regulator heat sink to the system board.
2. Lift the heat sink off the system board.

## Installing the voltage-regulator heat sink - Location 1

### Prerequisites

If you are replacing a component, remove the existing component before performing the installation procedure.

### About this task

The following image indicates the location of the voltage-regulator heat sink and provides a visual representation of the installation procedure.



2x  
M3x5

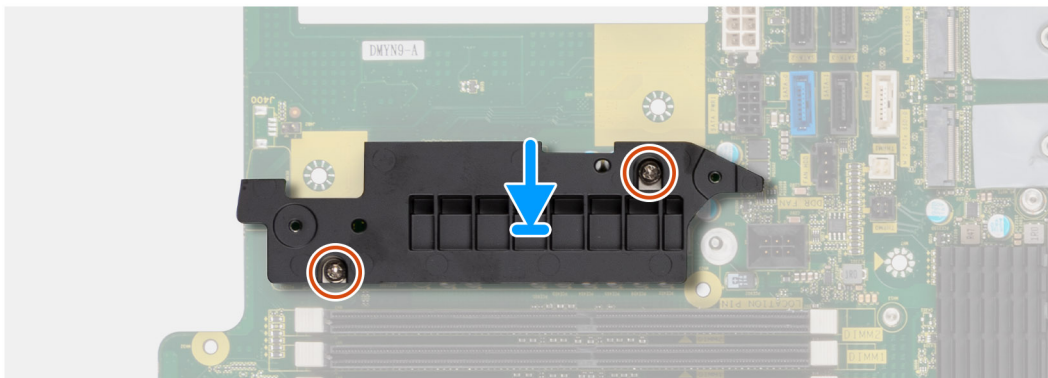
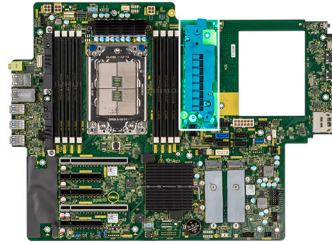

### Steps

1. Align the screw holes on the voltage-regulator heat sink to the screw holes on the system board and adhere the voltage-regulator heat sink to the system board.
2. Install the two (M3x5) screws that secure the voltage-regulator heat sink to the system board.

### Next steps

1. Install the [air shroud](#).
2. Install the [side cover](#).
3. Follow the procedure in [After working inside your computer](#).

## Removing the voltage-regulator heat sink - Location 2

### Prerequisites

1. Follow the procedure in [Before working inside your computer](#).

 **WARNING:** The heat sink may become hot during normal operation. Allow sufficient time for the heat sink to cool before you touch it.

 **CAUTION:** For maximum cooling of the processor, do not touch the heat transfer areas on the heat sink. The oils in your skin can reduce the heat transfer capability of the thermal grease.

2. Remove the [side cover](#).
3. remove the [air shroud](#).

### About this task

The following image indicates the location of the voltage-regulator heat sink and provides a visual representation of the removal procedure.



2x

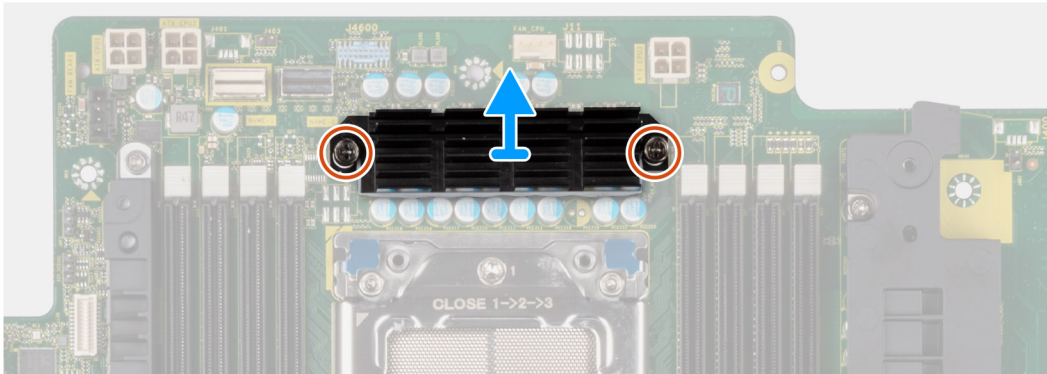
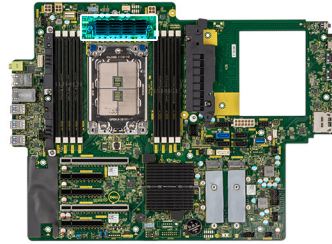

### Steps

1. Loosen the two captive screws that secure the voltage-regulator heat sink to the system board.
2. Lift the heat sink off the system board.

## Installing the voltage-regulator heat sink - Location 2

### Prerequisites

If you are replacing a component, remove the existing component before performing the installation procedure.

### About this task

The following image indicates the location of the voltage-regulator heat sink and provides a visual representation of the installation procedure.



2x

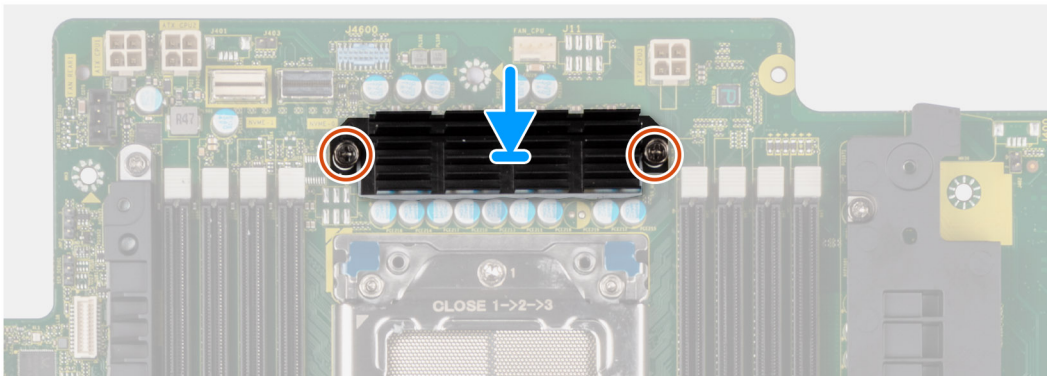
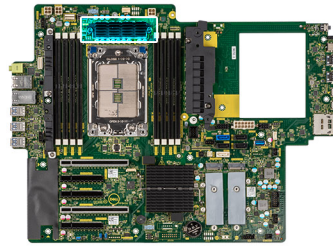

### Steps

1. Align the screw holes on the voltage-regulator heat sink to the screw holes on the system board and adhere the voltage-regulator heat sink to the system board.
2. Tighten the two captive screws that secure the voltage-regulator heat sink to the system board.

### Next steps

1. Install the [air shroud](#).
2. Install the [side cover](#).
3. Follow the procedure in [After working inside your computer](#).

## Removing the voltage-regulator heat sink - Location 3

### Prerequisites

1. Follow the procedure in [Before working inside your computer](#).

 **WARNING:** The heat sink may become hot during normal operation. Allow sufficient time for the heat sink to cool before you touch it.

 **CAUTION:** For maximum cooling of the processor, do not touch the heat transfer areas on the heat sink. The oils in your skin can reduce the heat transfer capability of the thermal grease.

2. Remove the [side cover](#).
3. remove the [air shroud](#).

### About this task

The following image indicates the location of the voltage-regulator heat sink and provides a visual representation of the removal procedure.



**3x**  
M3x5

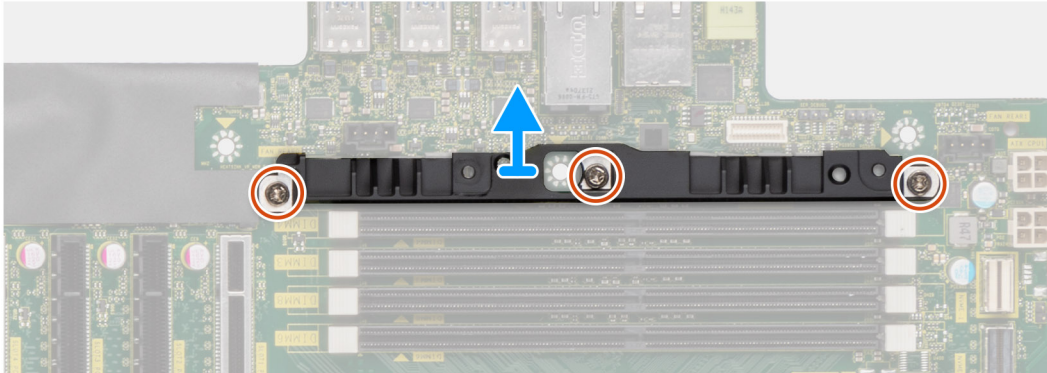
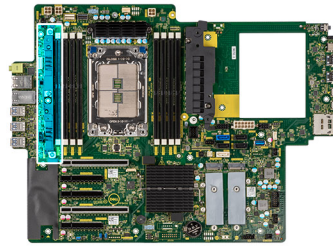

### Steps

1. Remove the three (M3x5) screws that secure the voltage-regulator heat sink to the system board.
2. Lift the heat sink off the system board.

## Installing the voltage-regulator heat sink - Location 3

### Prerequisites

If you are replacing a component, remove the existing component before performing the installation procedure.

### About this task

The following image indicates the location of the voltage-regulator heat sink and provides a visual representation of the installation procedure.



**3x**  
M3x5

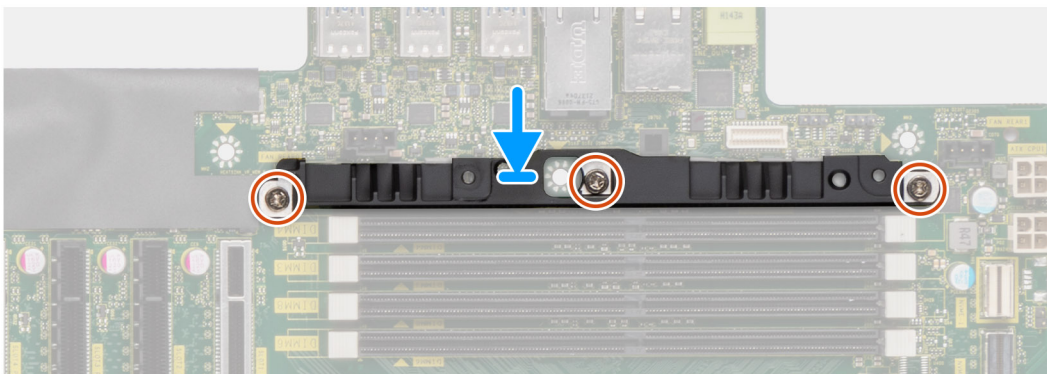
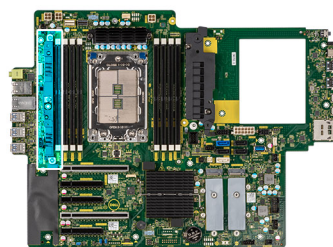

### Steps

1. Align the screw holes on the voltage-regulator heat sink to the screw holes on the system board and adhere the voltage-regulator heat sink to the system board.
2. Replace the three (M3x5) screws to secure the voltage-regulator heat sink to the system board.

### Next steps

1. Install the [air shroud](#).
2. Install the [side cover](#).
3. Follow the procedure in [After working inside your computer](#).

## Power-supply unit

### Removing the power-supply unit

#### Prerequisites

1. Follow the procedure in [Before working inside your computer](#).
2. Remove the [side cover](#).
3. Remove the [air shroud](#).

 **NOTE:** Note the routing of all cables as you remove them so that you can route them correctly while you are replacing the power-supply unit.

#### About this task

The following images indicate the location of the power-supply unit and provide a visual representation of the removal procedure.



6x  
#6-32

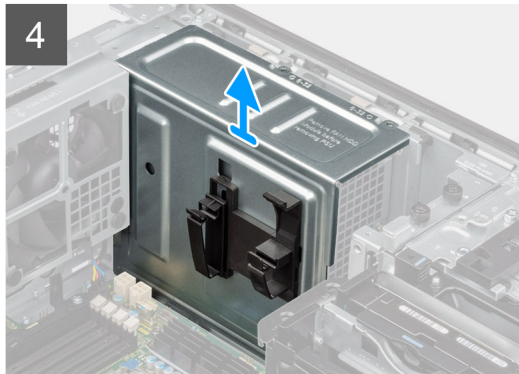
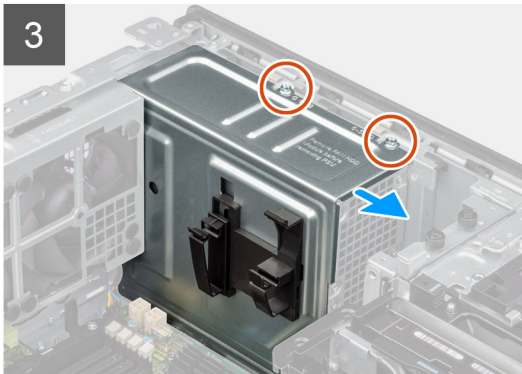
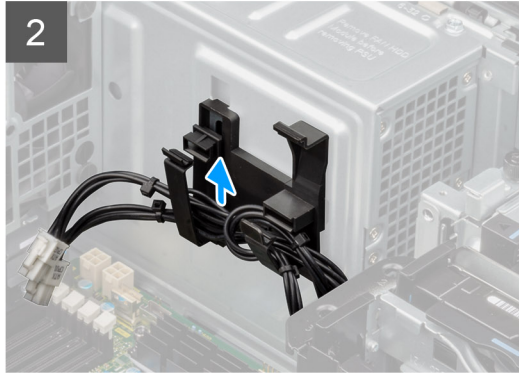
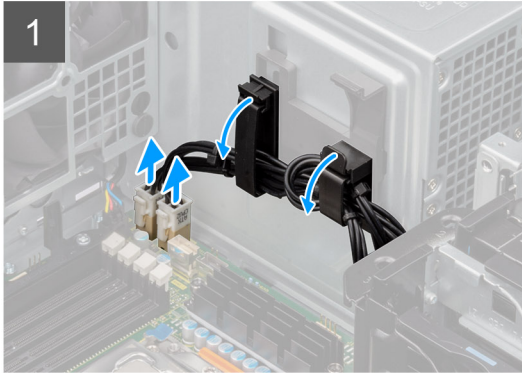
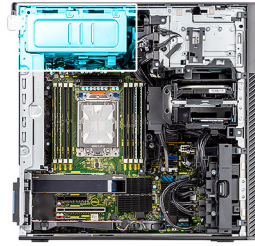

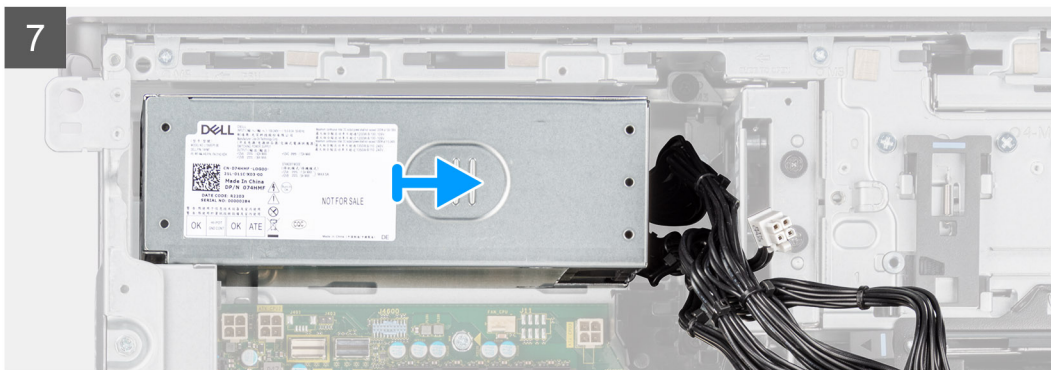
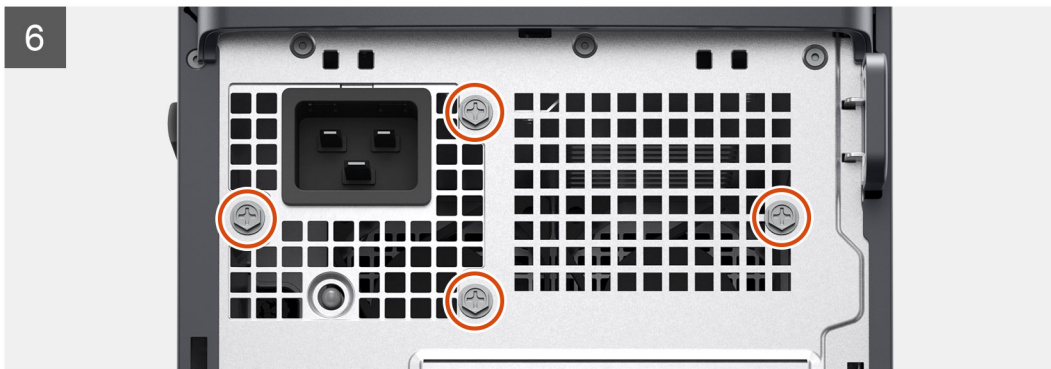

## Steps

1. Lay the computer on the right side.
2. Disconnect the ATX CPU power-cables from the connectors on the system board.
3. Open the clips on the routing guides on the power-supply cover and remove the CPU ATX power-cables from the clips.
4. Remove the four (#6-32) screws from the power-supply cover.
5. Remove the power-supply cover from the computer.
6. Disconnect the SATA power-cables from the connectors on the system board.
7. Disconnect the PCIe power-cables from the PCIe holder.
8. Open the bottom-air shroud cover and remove the cables from inside it.
9. Remove the four (#6x32) screws that secure the power-supply unit to the chassis.
10. Slide the power-supply unit away from the back of the chassis.
11. Lift the power-supply unit off the chassis.

## Installing the power-supply unit

### Prerequisites

If you are replacing a component, remove the existing component before performing the installation procedure.

 **WARNING: The cables and ports on the back of the power-supply unit are color-coded to indicate the different power wattage. Ensure that you plug in the cable to the correct port. Failure to do so may result in damaging the power-supply unit and/or system components.**

### About this task

The following images indicate the location of the power-supply unit and provide a visual representation of the installation procedure.



6x  
#6-32

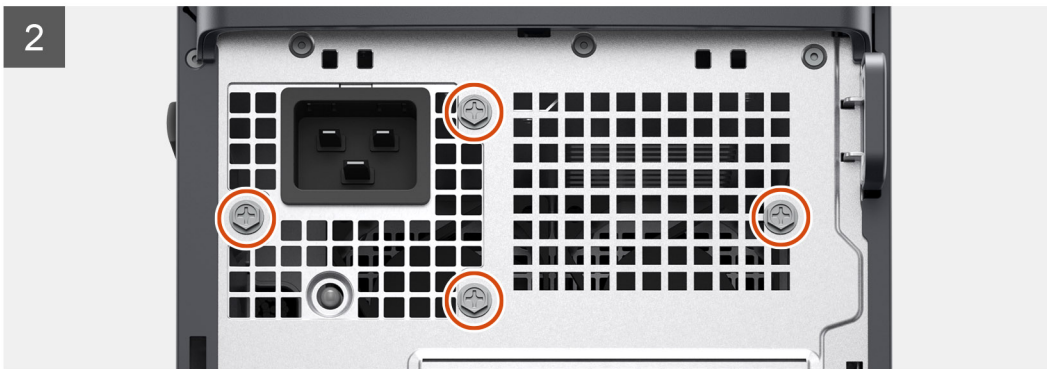
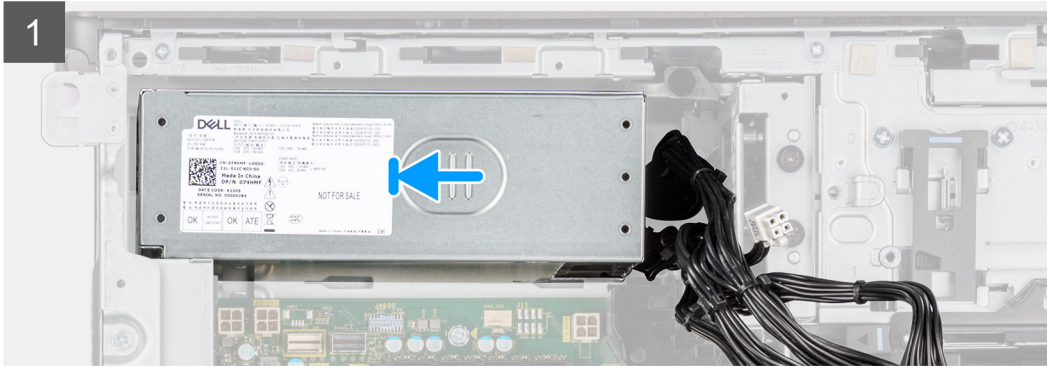
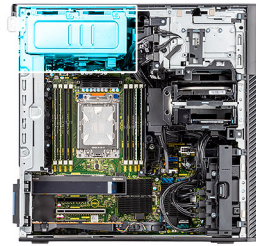

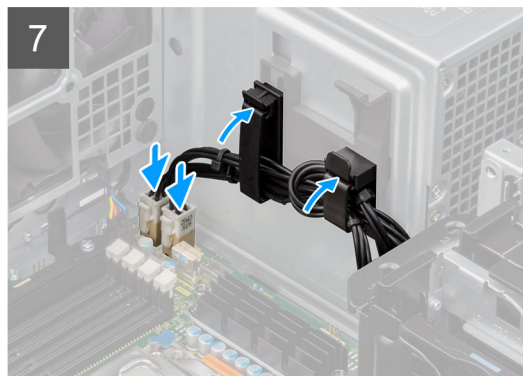
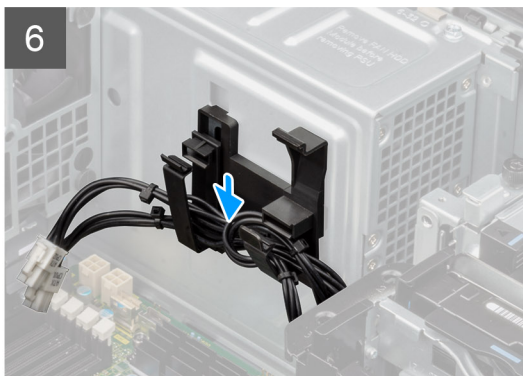
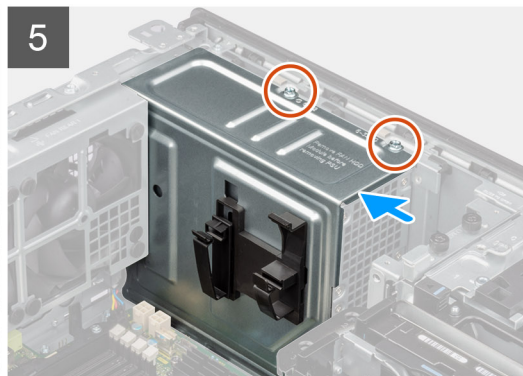
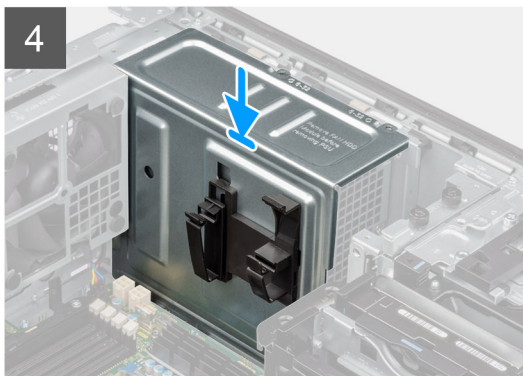

## Steps

1. Slide the power-supply unit into the chassis until the securing tab snaps into position.
2. Replace the four (#6x32) screws to secure the power-supply unit to the chassis.
3. Route the PCIe power-cables and SATA power-cables through the bottom-air shroud.
4. Close the bottom-air shroud cover.
5. Connect the PCIe power-cables to the slots on the PCIe holder.
6. Connect the SATA power-cables to the connectors on the system board.
7. Align and place the power-supply cover over the power-supply unit.
8. Install the two (#6-32) screws to secure the power-supply cover to the chassis.
9. Open the clips on the routing guides on the power-supply cover and route the CPU ATX power-cables through the clips.
10. Close the clips on the routing guides on the power-supply cover.
11. Connect the ATX CPU power-cables to the connectors on the system board..

## Next steps

1. Install the [air shroud](#).
2. Install the [side cover](#).
3. Follow the procedure in [After working inside your computer](#).

# System board

## System-board call outs

This topics provides detailed call outs for the connectors on the system board:

### System-board call outs

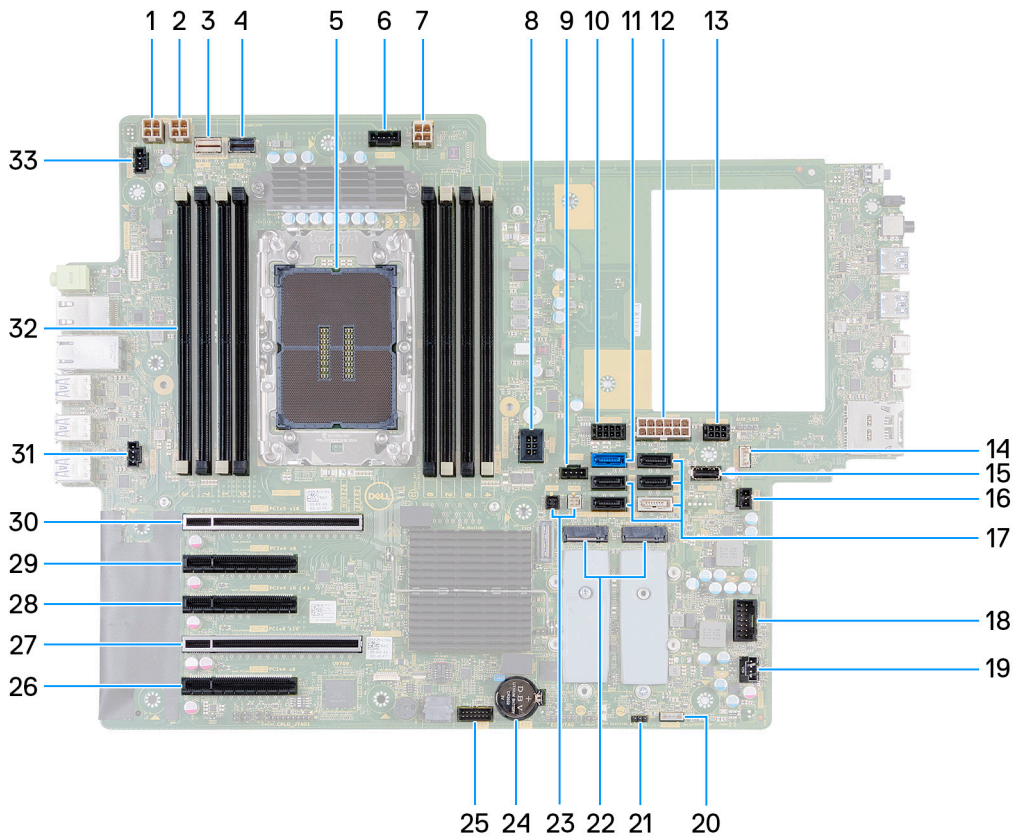

**Table 2. Precision 5860 tower system board callouts**

| No | Connector | Description  |
|----|-----------|--|
| 1  | ATX CPU1  | 4-pin processor power connector                        |
| 2  | ATX CPU2  | 4-pin processor power connector                        |
| 3  | NVME1     | NVMe connector for externally facing M.2 flexbay drive |
| 4  | NVME0     | NVMe connector for externally facing M.2 flexbay drive |
| 5  | CPU0_SKT  | Processor socket                                       |
| 6  | FAN_CPU   | Processor fan connector                                |
| 7  | ATX CPU3  | 4-pin processor power connector                        |
| 8  | DDR FAN   | Memory-module fan connector                            |
| 9  | FAN HDD   | Hard-drive fan connector                               |

**Table 2. Precision 5860 tower system board callouts (continued)**

| No | Connector  | Description  |
|----|--|--|
| 10 | SATA PWR1  | SATA power connector   |
| 11 | SATA-0   | Primary SATA Hard drive data cable connector   |
| 12 | ATX SYS  | System-board power connector   |
| 13 | SATA PWR2  | SATA power connector   |
| 14 | INT SPKR   | Internal-speaker connector   |
| 15 | INT USB2   | USB 3.2 Gen1 port to accommodate standard USB storage key  |
| 16 | INTRUSION  | Intrusion switch connector   |
| 17 | <ul style="list-style-type: none"> <li>● SATA-1</li> <li>● SATA-2</li> <li>● SATA-3</li> <li>● SATA-4</li> <li>● SATA-5</li> </ul> | <ul style="list-style-type: none"> <li>● SATA device data cable connector</li> <li>● SATA device data cable connector</li> <li>● SATA device data cable connector</li> <li>● SATA device data cable connector</li> <li>● SATA device data cable connector</li> </ul> |
| 18 | INT USB1   | Internal USB 2.0   |
| 19 | FAN SYS  | System fan connector   |
| 20 | VROC Key   | Intel Virtual RAID on CPU  |
| 21 | PWR REMOTE   | System fan connector   |
| 22 | <ul style="list-style-type: none"> <li>● M.2 PCIe SSD-0</li> <li>● M.2 PCIe SSD-1</li> </ul>                                       | <ul style="list-style-type: none"> <li>● M.2280/M.2230 Solid-state drive socket</li> <li>● M.2280/M.2230 Solid-state drive socket</li> </ul>   |
| 23 | <ul style="list-style-type: none"> <li>● THRM0</li> <li>● THRM1</li> </ul>   | <ul style="list-style-type: none"> <li>● Thermal sensor 0 connector</li> <li>● Thermal sensor 1 connector</li> </ul>   |
| 24 | RTC  | Coin cell battery  |
| 25 | TBT  | Thunderbolt add-in card connector  |
| 26 | SLOT5 PCIe4 x8   | PCI Express Gen 4 x8 slot  |
| 27 | SLOT4 PCIe4 x16  | PCI Express Gen 4 x16 slot   |
| 28 | SLOT3 PCIe4 x8   | PCI Express Gen 4 x8 slot  |
| 29 | SLOT2 PCIe4 x8   | PCI Express Gen 4 x8 slot  |
| 30 | SLOT1 PCIe5 x16  | PCI Express Gen 5 x16 slot   |
| 31 | Fan Rear0  | Rear Fan 0   |
| 32 | DIMM1 - DIMM8  | Memory module connectors   |
| 33 | Fan Rear1  | Rear Fan 1   |

## Removing the system board

### Prerequisites

1. Follow the procedure in [Before working inside your computer](#).

**NOTE:** Your computer's Service Tag is stored in the system board. You must enter the Service Tag in the BIOS setup program after you replace the system board.

**NOTE:** Replacing the system board removes any changes that you have made to the BIOS using the BIOS setup program. You must make the appropriate changes again after you replace the system board.

**NOTE:** Before disconnecting the cables from the system board, note the location of the connectors so that you can reconnect the cables correctly after you replace the system board.

2. Remove the [side cover](#).
3. Remove the [front bezel](#).
4. Remove the [front I/O bracket](#).
5. Remove the [air shroud](#).
6. Remove the [PCIe holder](#).
7. Remove the [3.5-inch hard drive/2.5-inch hard drive](#).
8. Remove the [memory module](#).
9. Remove the [M.2 2230 SSD/M.2 2280 SSD](#).
10. Remove the [hard-drive fan assembly](#).
11. Remove the [internal hard-drive cage](#).
12. Remove the [powered GPU](#).

**NOTE:** Remove the graphics-card rubber protector from the chassis before removing the system board.

13. Remove the [intrusion switch](#).
14. Remove the [heat-sink assembly](#).
15. Remove the [front-fan assembly](#) and [rear-fan assembly](#).
16. Remove the [power-supply unit](#).

**NOTE:** Remove the power-supply cable clips from the power-supply cover before removing the system board.

17. Remove the [processor](#).

#### **About this task**

The following images indicate the location of the system board and provide a visual representation of the removal procedure.



11x  
#6-32



2x  
M3x5

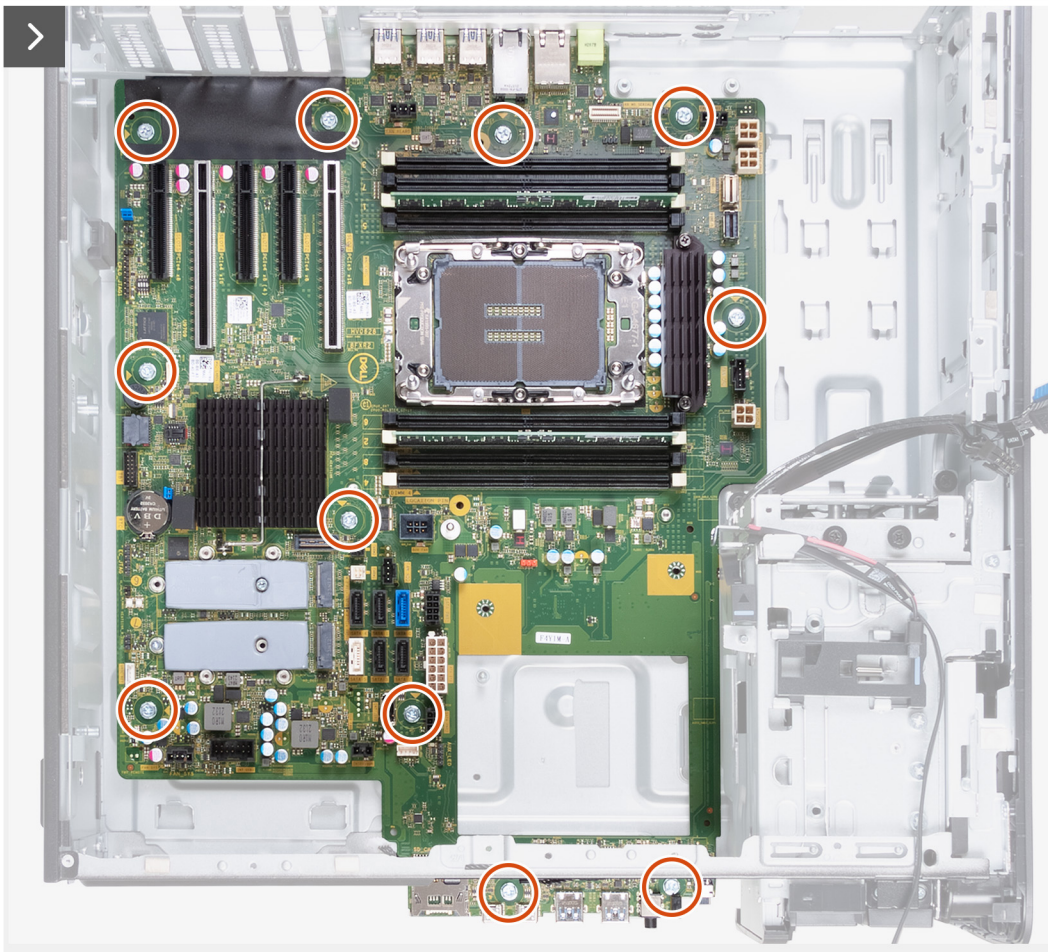
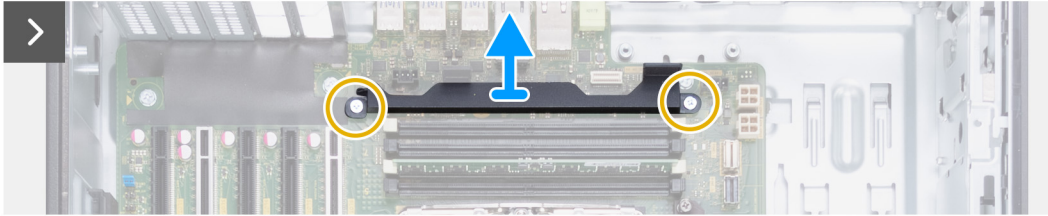
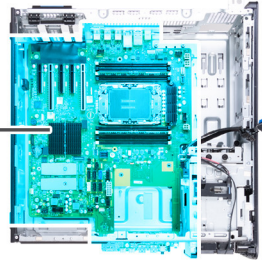

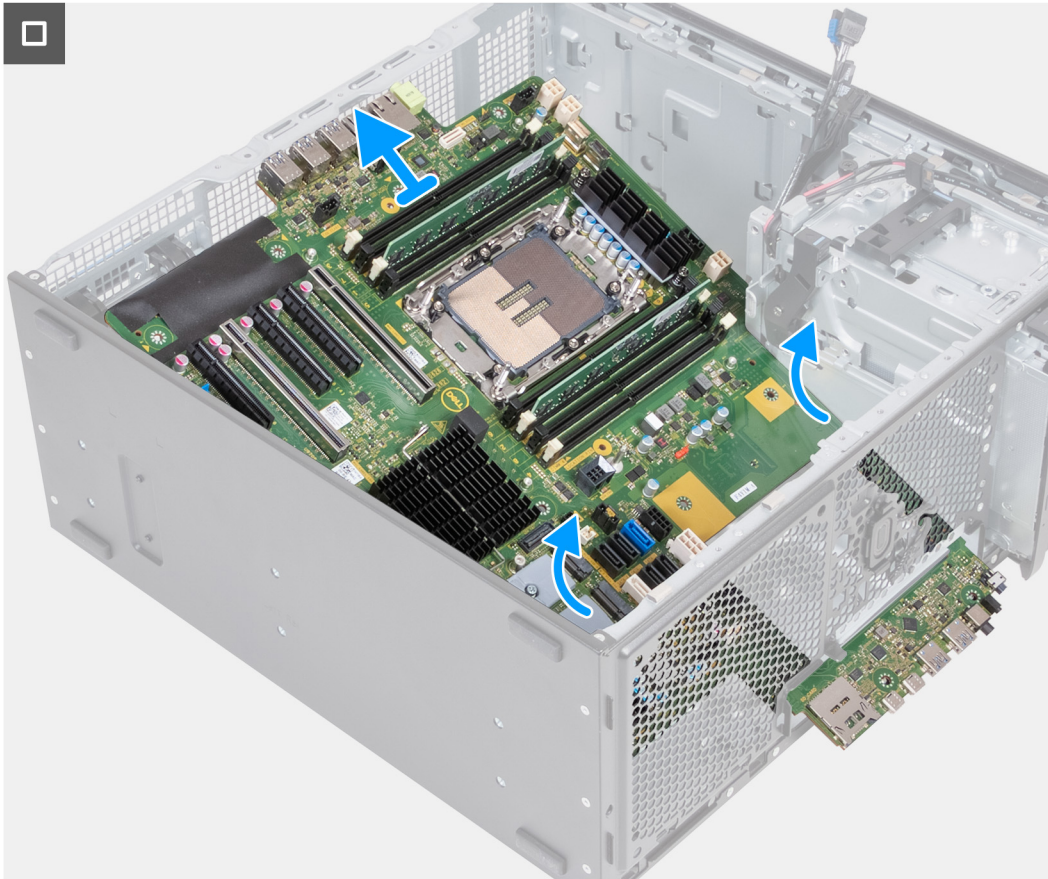

### Steps

1. Remove the two (M3) screws that secure the supporting bracket to the system board.
2. Remove the eleven (#6-32) screws that secure the system board to the chassis.
3. Lift the system board at an angle and remove the system board off the chassis.

## Installing the system board

### Prerequisites

If you are replacing a component, remove the existing component before performing the installation procedure.

### About this task

The following images indicate the location of the system board and provide a visual representation of the installation procedure.



11x  
#6-32



2x  
M3x5

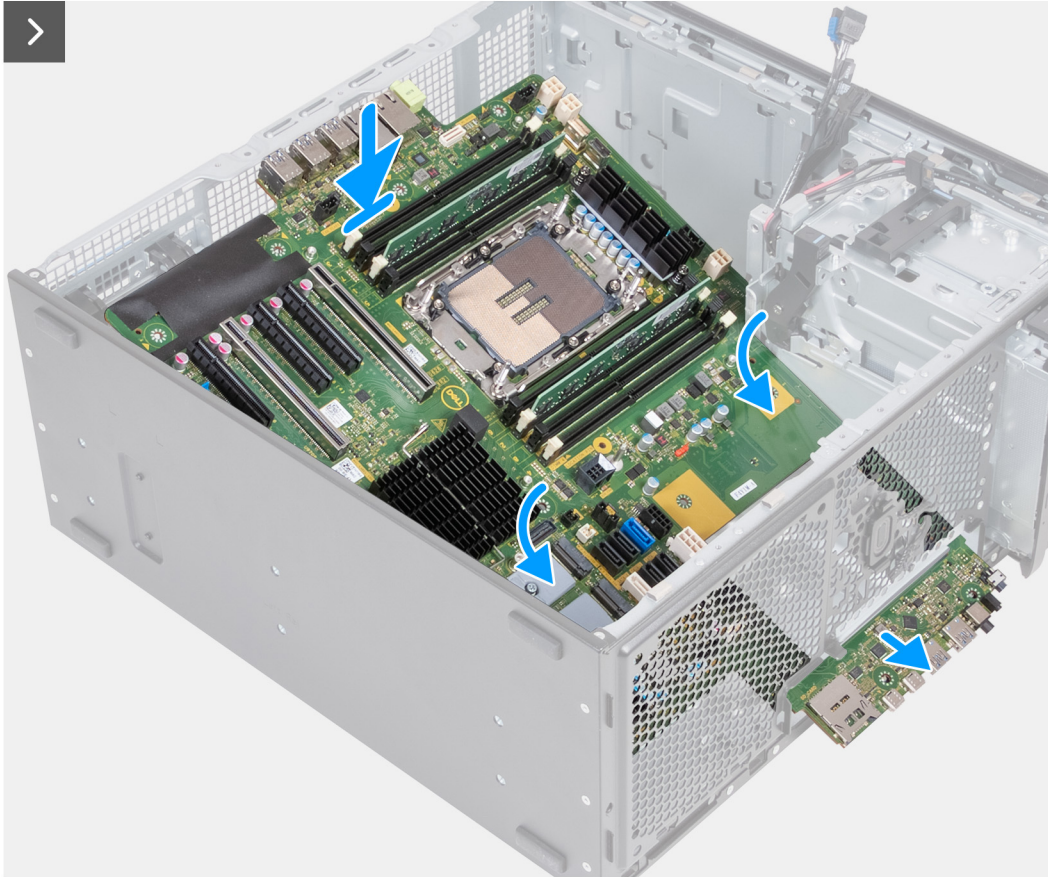

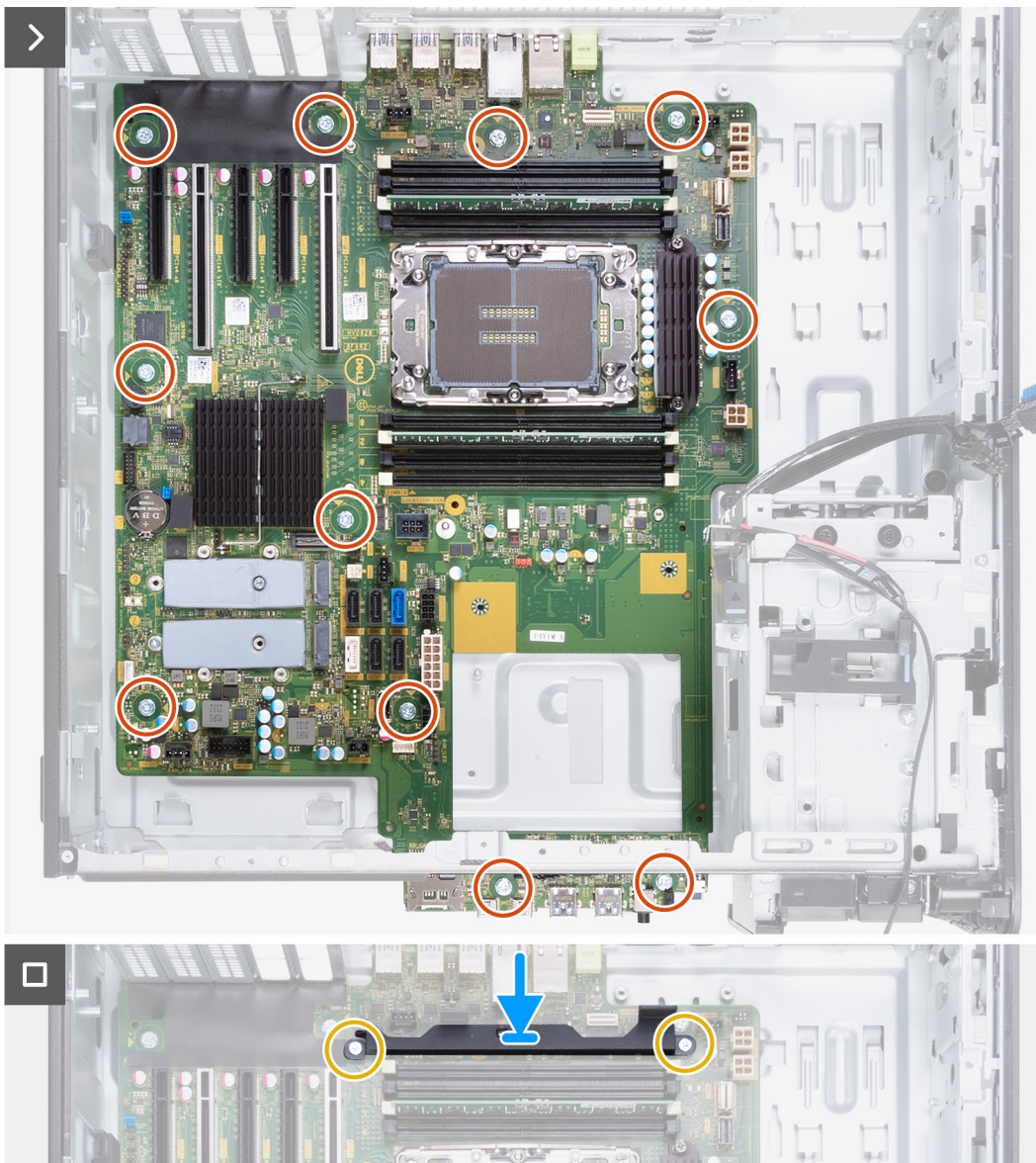

### Steps

1. Slide the front I/O-ports on the system board into the front I/O-slots on the chassis and align the screw holes on the system board with the screw holes on the chassis.
2. Replace the eleven (#6-32) screws that secure the system board to the chassis.
3. Align and place the supporting bracket on the system board.
4. Install the two (M3) screws to secure the supporting bracket to the system board

### Next steps

1. Install the [processor](#).
2. Install the [power-supply unit](#).
  - NOTE:** Install the power-supply cable clips to the power-supply cover replacing the system board.
3. Install the [front-fan assembly](#) and [rear-fan assembly](#).
4. Install the [heat-sink assembly](#).
5. Install the [intrusion switch](#).
6. Install the [powered GPU](#).
  - NOTE:** Install the graphics-card rubber protector to the chassis after replacing the system board.
7. Install the [internal hard-drive cage](#).

8. Install the [hard-drive fan assembly](#).
  9. Install the [M.2 2230 SSD/M.2 2280 SSD](#).
  10. Install the [memory module](#).
  11. Install the [3.5-inch hard drive/2.5-inch hard drive](#).
  12. Install the [PCIe holder](#).
  13. Install the [air shroud](#).
  14. Install the [front I/O bracket](#).
  15. Install the [front bezel](#).
  16. Install the [side cover](#).
  17. Follow the procedure in [After working inside your computer](#).
- NOTE:** Your computer's Service Tag is stored in the system board. You must enter the Service Tag in the BIOS setup program after you replace the system board.
- NOTE:** Replacing the system board removes any changes that you have made to the BIOS using the BIOS setup program. You must make the appropriate changes again after you replace the system board.

## Rail kit

### Removing the right rail-kit

#### Prerequisites

1. Follow the procedure in [Before working inside your computer](#).
2. Remove the [side cover](#).

#### About this task

The following images indicate the location of the right rail-kit and provide a visual representation of the removal procedure.



**4x**  
M6x32

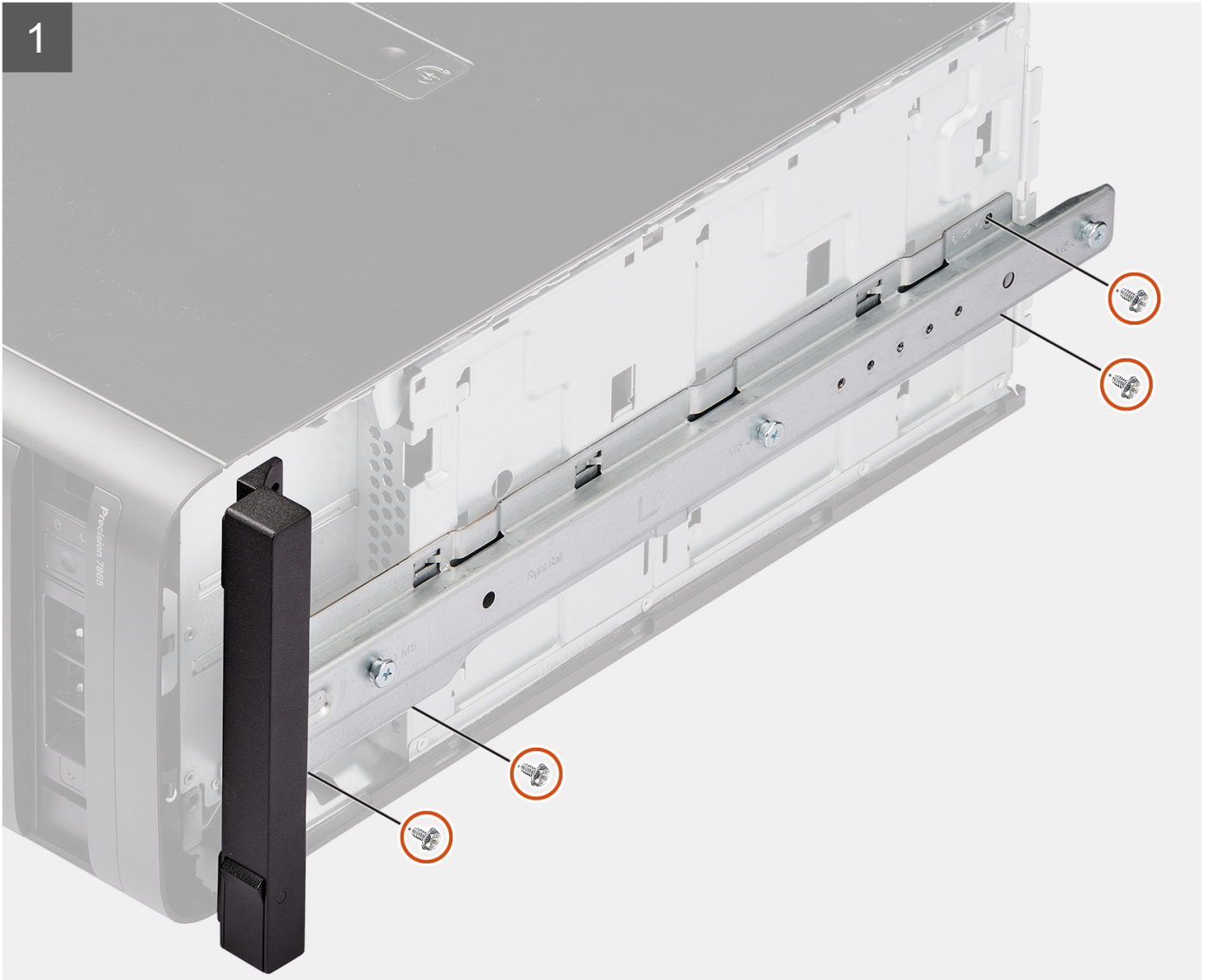

2

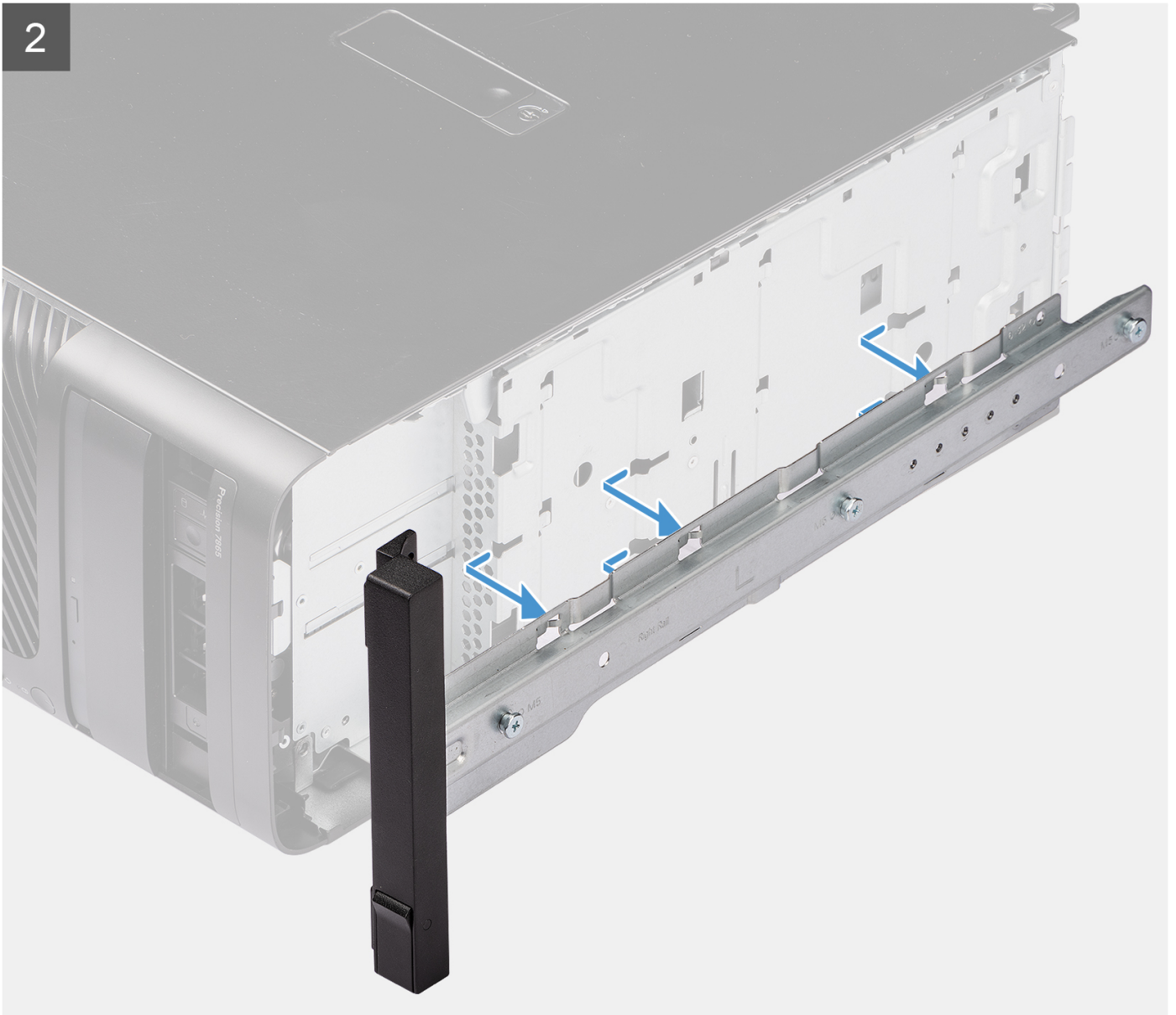

3

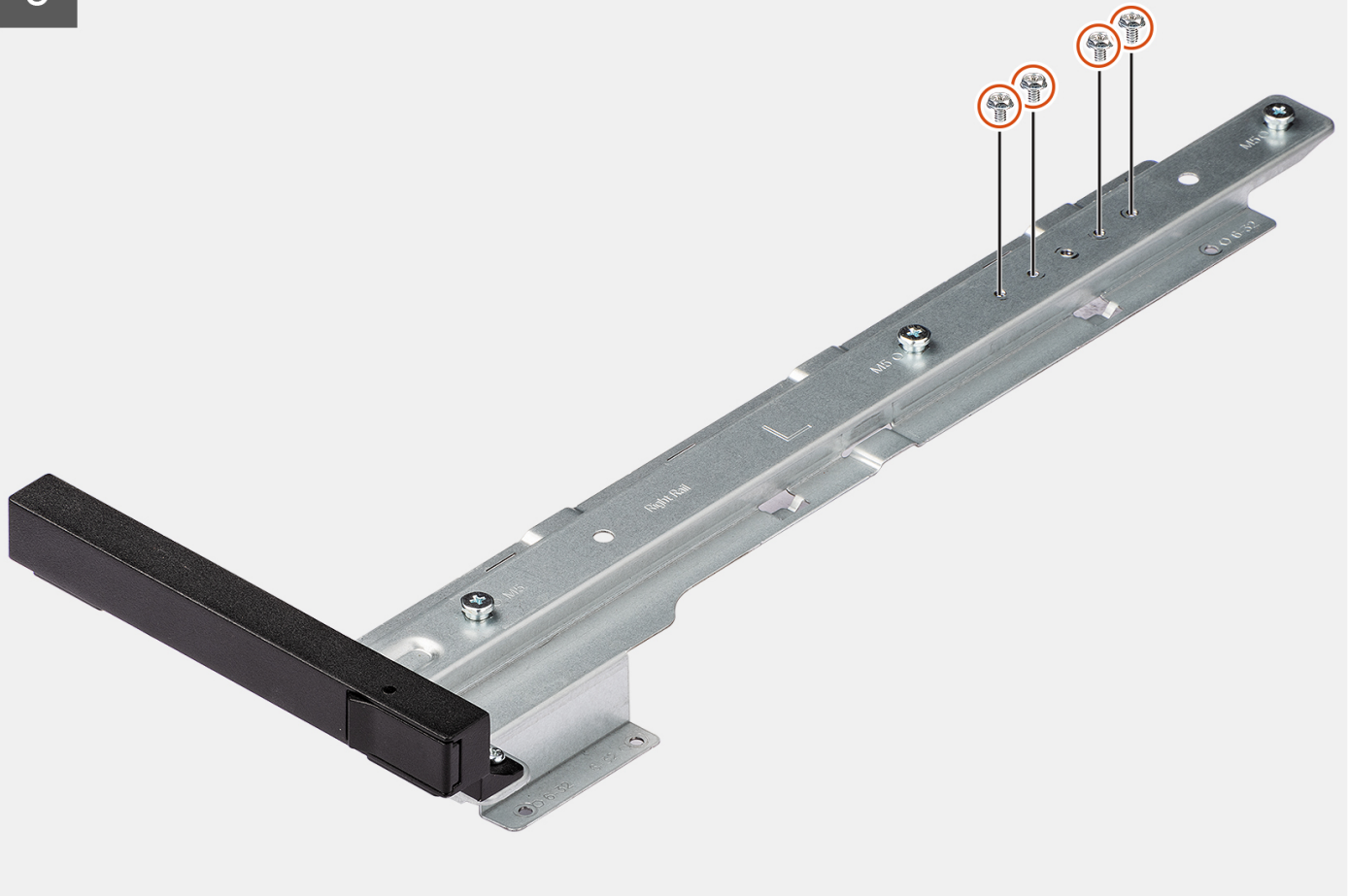

### Steps

1. Remove the four screws (M6x32) that secure the right rail-kit to the chassis.
2. Slide and remove the rail-kit from the slots on the chassis.
3. Replace the four screws (M6x32) to the rail-kit.

## Installing the right rail-kit

### Prerequisites

If you are replacing a component, remove the existing component before performing the installation procedure.

### About this task

The following images indicate the location of the right rail-kit and provide a visual representation of the installation procedure.



**4x**  
M6x32

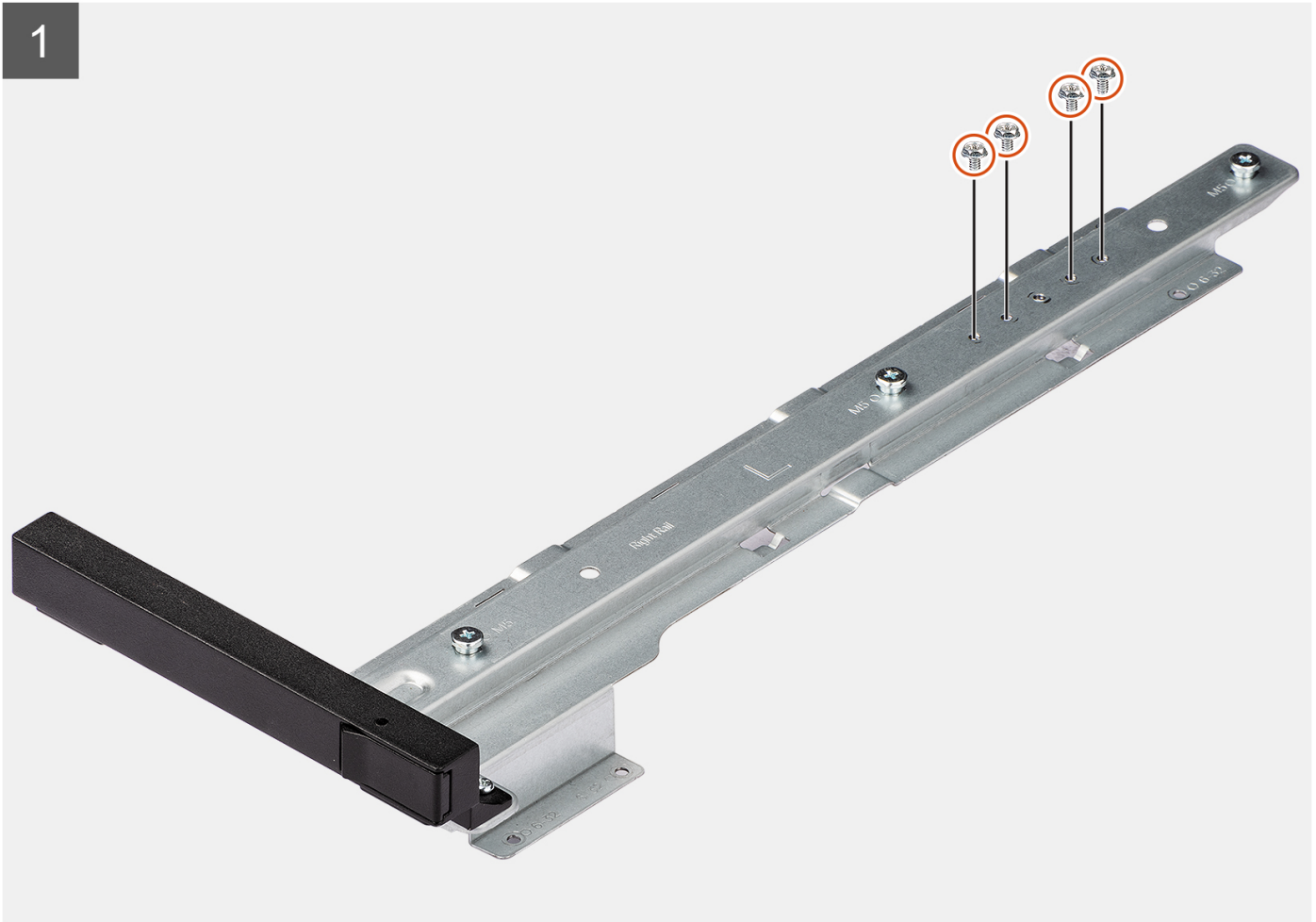

2

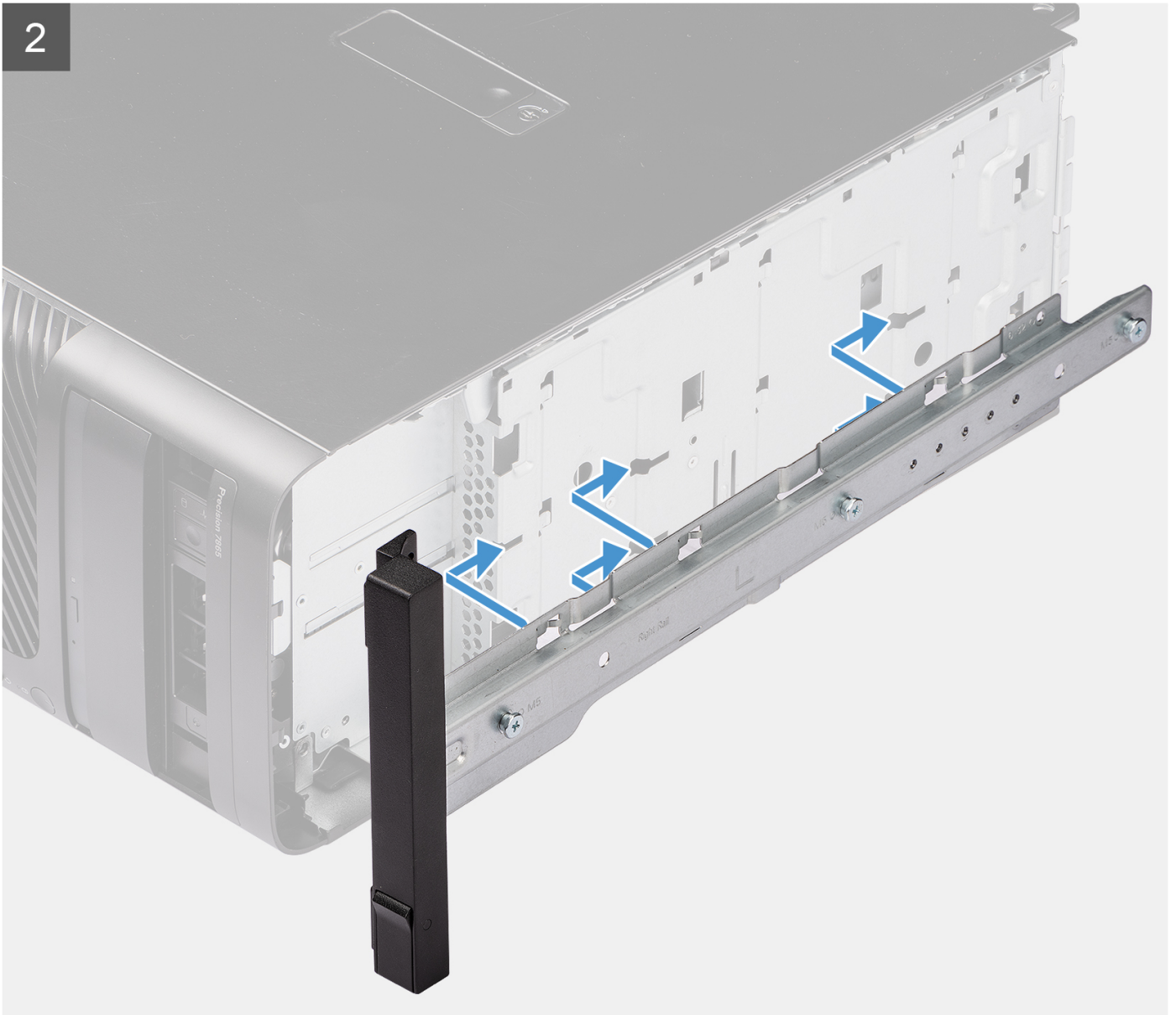

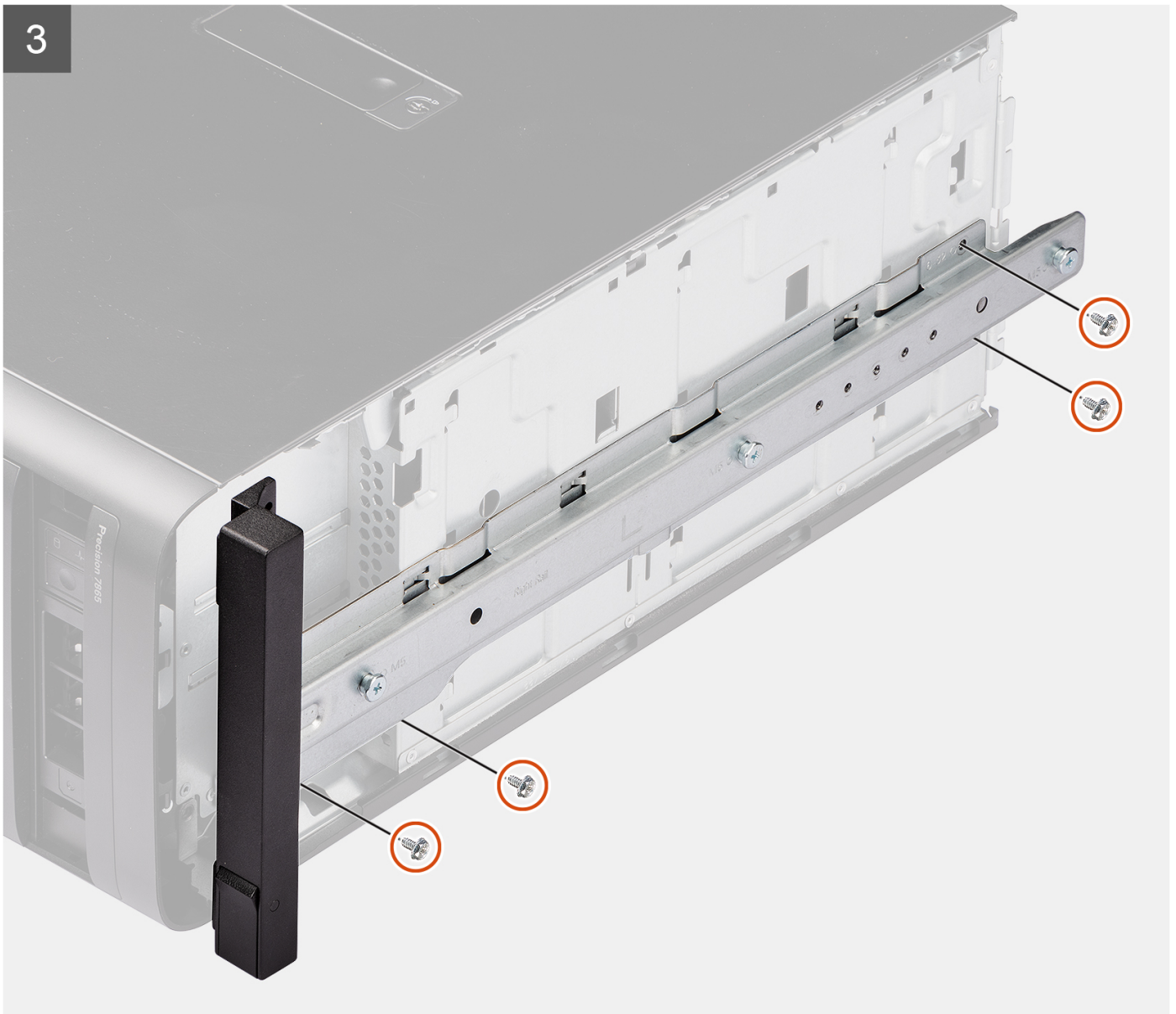

### Steps

1. Remove the four screws (M6x32) from the rail-kit.
2. Align the right rail-kit with the slots on the chassis and slide to secure it in place.
3. Replace the four screws (M6x32) to secure the right rail-kit to the chassis

### Next steps

1. Install the [side cover](#).
2. Follow the procedure in [After working inside your computer](#).

## Removing the left rail-kit

### Prerequisites

1. Follow the procedure in [Before working inside your computer](#).
2. Remove the [side cover](#).

**About this task**

The following images indicate the location of the left rail-kit and provide a visual representation of the removal procedure.



**6x**  
M6x32

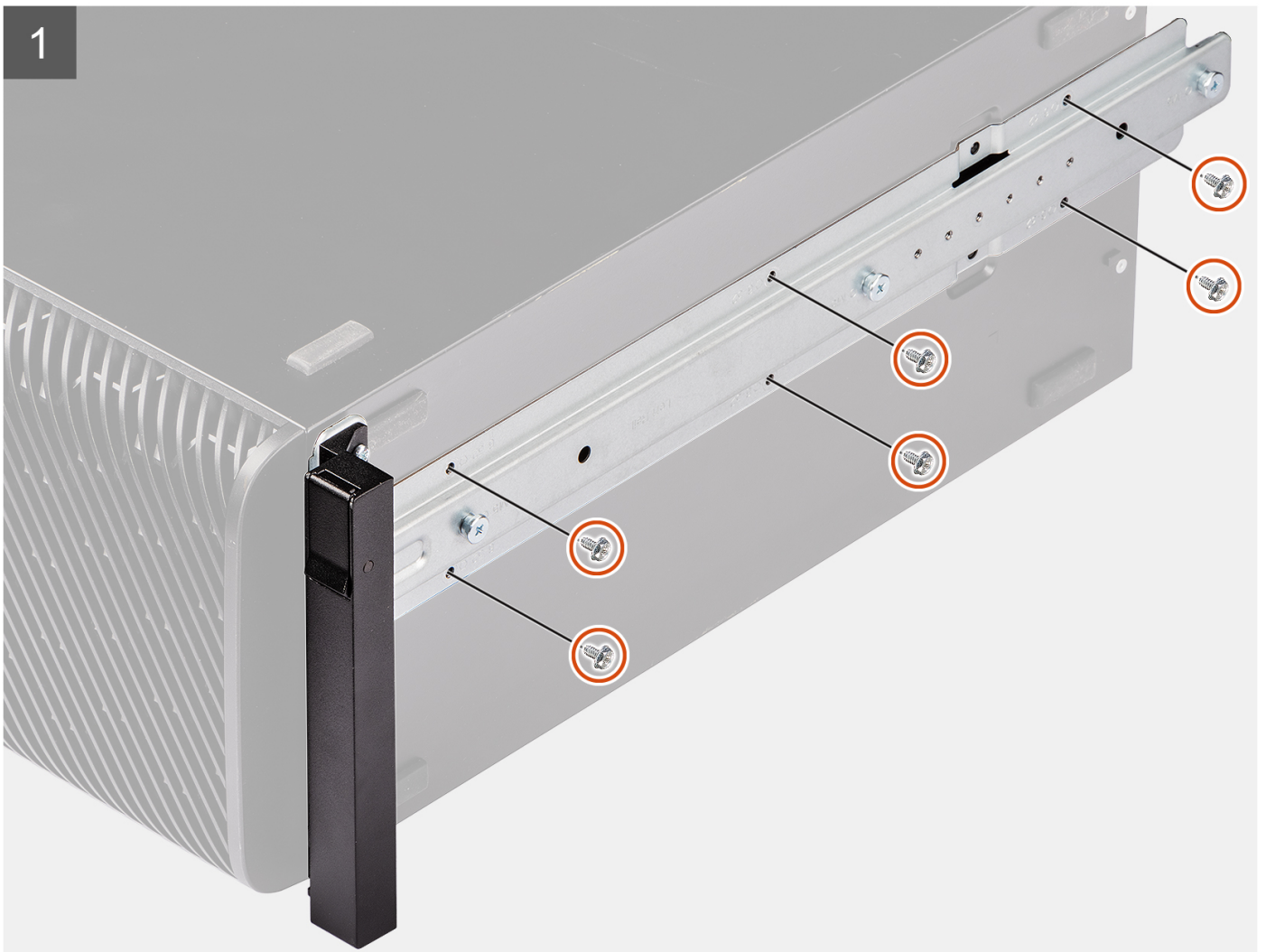

2

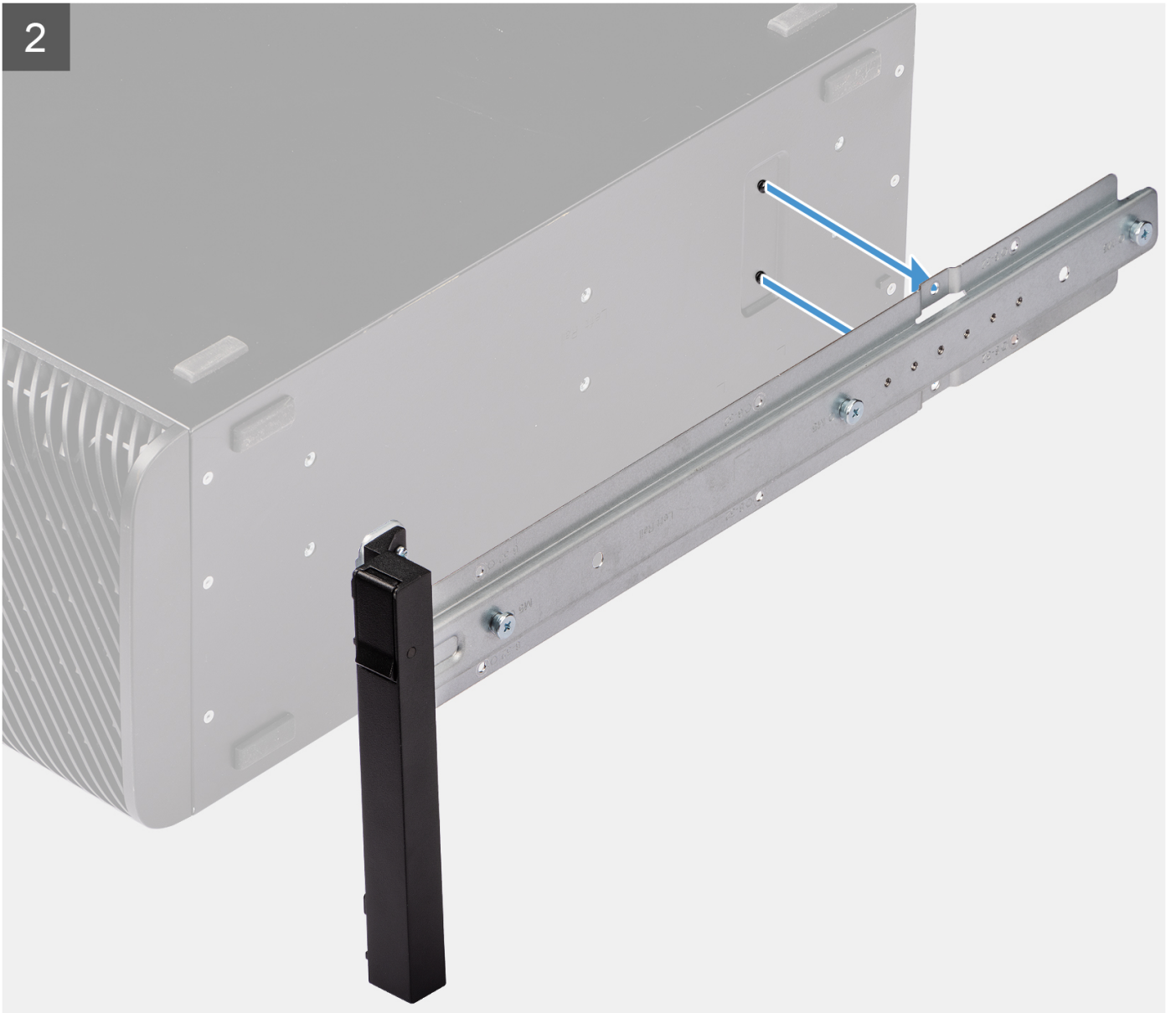

3

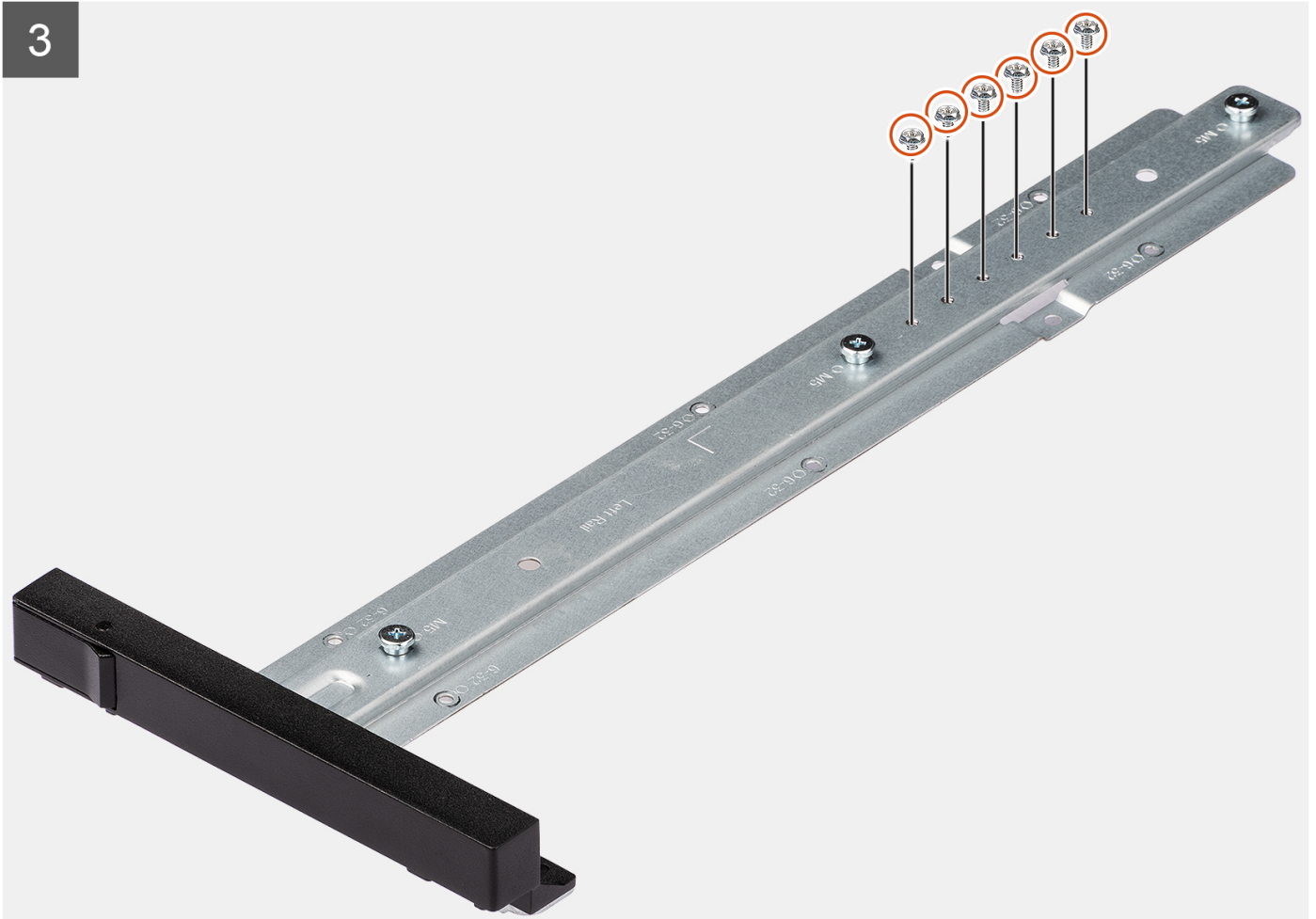

### Steps

1. Remove the six screws (M6x32) that secure the left rail-kit to the chassis.
2. Remove the rail-kit from the chassis.
3. Replace the four screws (M6x32) to the rail-kit.

## Installing the left rail-kit

### Prerequisites

If you are replacing a component, remove the existing component before performing the installation procedure.

### About this task

The following images indicate the location of the left rail-kit and provide a visual representation of the installation procedure.



**6x**  
M6x32

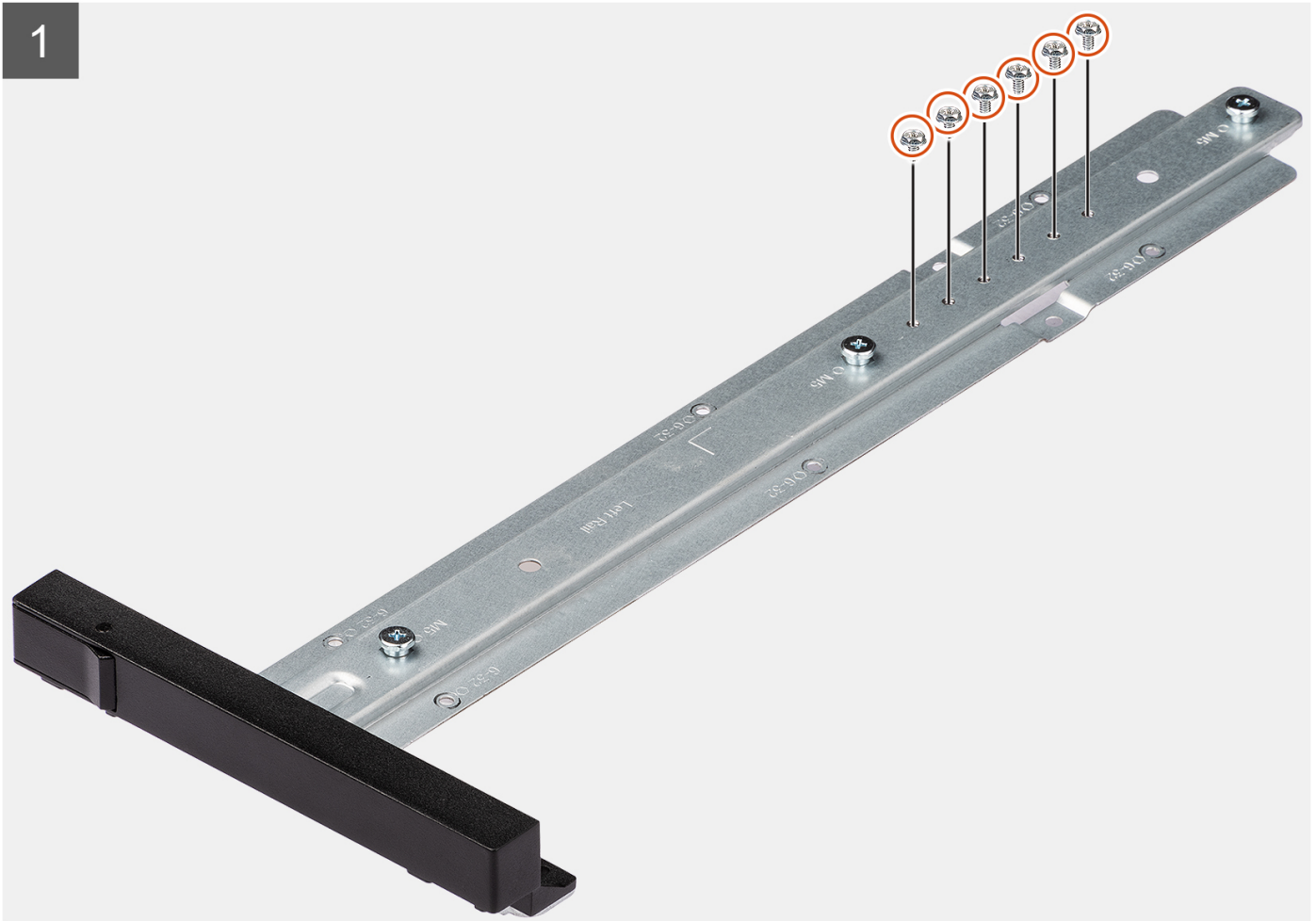

2

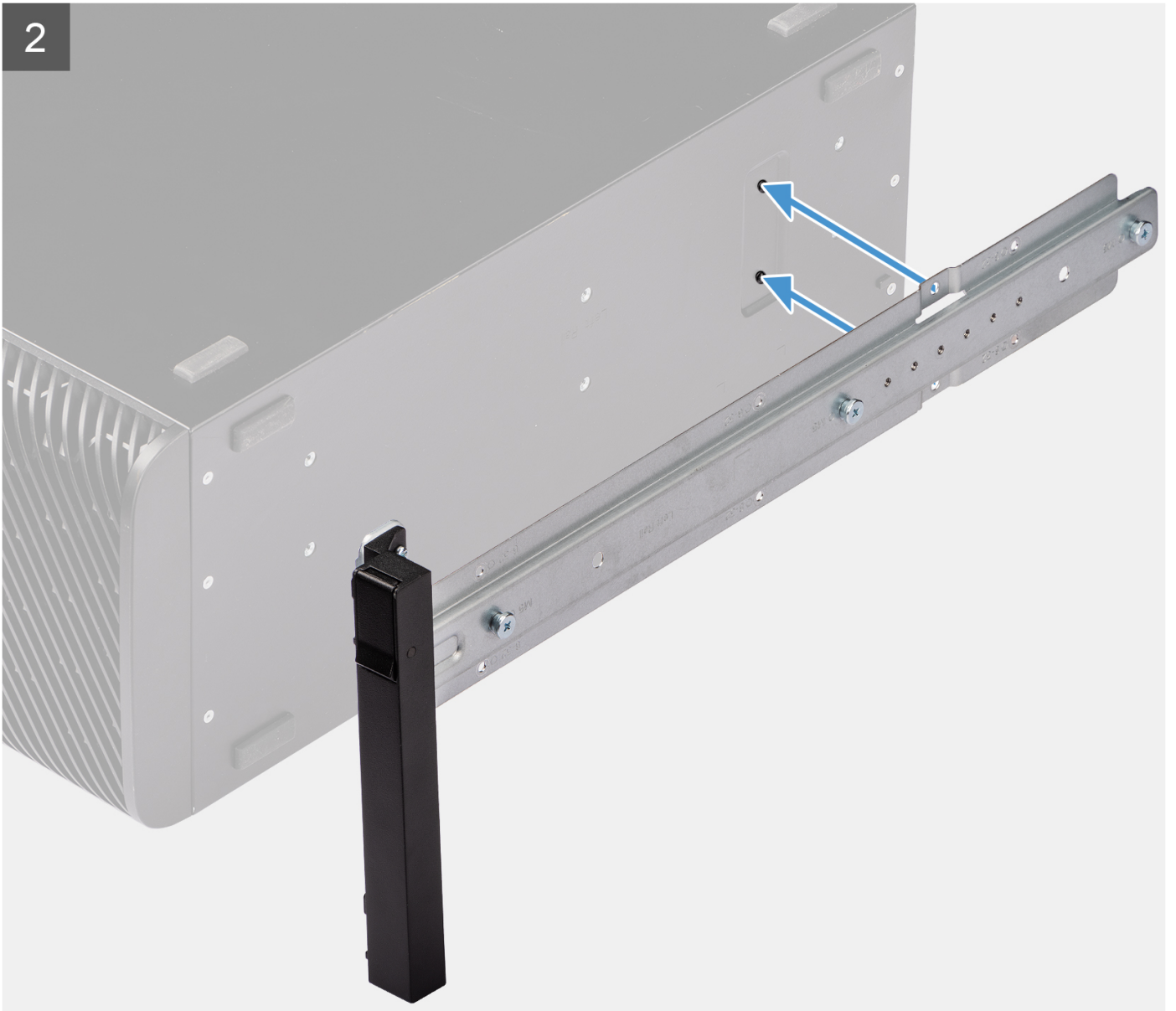

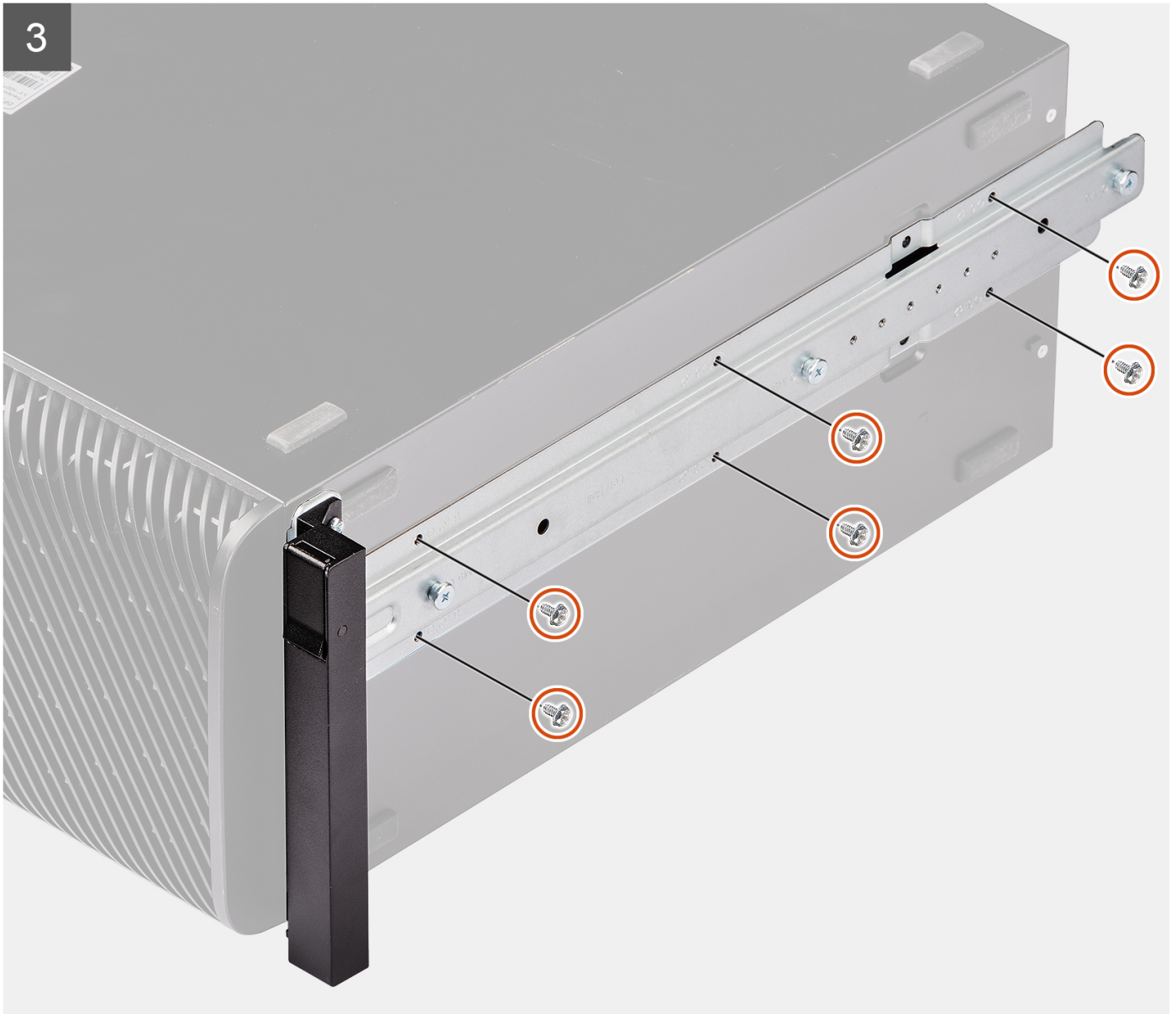

### Steps

1. Remove the six screws (M6x32) from the rail-kit.
2. Align the screw holes on the left rail-kit with the screw holes on the chassis.
3. Replace the six screws (M6x32) to secure the left rail-kit to the chassis

### Next steps

1. Install the [side cover](#).
2. Follow the procedure in [After working inside your computer](#).

## Drivers and downloads

When troubleshooting, downloading or installing drivers it is recommended that you read the Dell Knowledge Base article, Drivers and Downloads FAQ [000123347](#).

# BIOS setup

**CAUTION:** Unless you are an expert computer user, do not change the settings in the BIOS Setup program. Certain changes can make your computer work incorrectly.

**NOTE:** Depending on the computer and its installed devices, the items listed in this section may or may not be displayed.

**NOTE:** Before you change BIOS Setup program, it is recommended that you write down the BIOS Setup program screen information for future reference.

Use the BIOS Setup program for the following purposes:

- Get information about the hardware installed in your computer, such as the amount of RAM and the size of the hard drive.
- Change the system configuration information.
- Set or change a user-selectable option, such as the user password, type of hard drive installed, and enabling or disabling base devices.

## Entering BIOS setup program

### About this task

Turn on (or restart) your computer and press F2 immediately.

## Navigation keys

**NOTE:** For most of the System Setup options, changes that you make are recorded but do not take effect until you restart the system.

**Table 3. Navigation keys**

| Keys       | Navigation  |
|------------|---|
| Up arrow   | Moves to the previous field.  |
| Down arrow | Moves to the next field.  |
| Enter      | Selects a value in the selected field (if applicable) or follow the link in the field.  |
| Spacebar   | Expands or collapses a drop-down list, if applicable.   |
| Tab        | Moves to the next focus area.<br><b>NOTE:</b> For the standard graphics browser only.   |
| Esc        | Moves to the previous page until you view the main screen. Pressing Esc in the main screen displays a message that prompts you to save any unsaved changes and restarts the system. |

## One time boot menu

To enter **one time boot menu**, turn on your computer, and then press F2 immediately.

**NOTE:** It is recommended to shutdown the computer if it is on.

The one-time boot menu displays the devices that you can boot from including the diagnostic option. The boot menu options are:

- Removable Drive (if available)
- STXXXX Drive (if available)
- **i** **NOTE:** XXX denotes the SATA drive number.
- Optical Drive (if available)
- SATA Hard Drive (if available)
- Diagnostics
- **i** **NOTE:** Choosing **Diagnostics**, will display the **ePSA diagnostics** screen.

The boot sequence screen also displays the option to access the System Setup screen.

## One Time Boot menu

To enter **One Time Boot menu**, turn on your computer, and then press F12 immediately.

**i** **NOTE:** It is recommended to shutdown the computer if it is on.

The one-time boot menu displays the devices that you can boot from including the diagnostic option. The boot menu options are:

- Removable Drive (if available)
- STXXXX Drive (if available)
- **i** **NOTE:** XXX denotes the SATA drive number.
- Optical Drive (if available)
- SATA Hard Drive (if available)
- Diagnostics

The boot sequence screen also displays the option to access the System Setup screen.

## System setup options

**i** **NOTE:** Depending on your system and its installed devices, the items that are listed in this section may or may not appear.

**Table 4. System setup options—System information menu**

| Overview                     |  |
|------------------------------|--|
| <b>Precision 5860 Tower</b>  |  |
| BIOS Version                 | Displays the BIOS version number.                                      |
| Service Tag                  | Displays the Service Tag of the system.                                |
| Asset Tag                    | Displays the Asset Tag of the system.                                  |
| Manufacture Date             | Displays the manufacture date of the system.                           |
| Ownership Date               | Displays the ownership date of the system.                             |
| Express Service Code         | Displays the express service code of the system.                       |
| Ownership Tag                | Displays the Ownership Tag of the system.                              |
| Signed Firmware Update       | Displays whether the Signed Firmware Update is enabled on your system. |
| <b>Processor Information</b> |  |
| Processor Type               | Displays the processor type.   |
| Maximum Clock Speed          | Displays the maximum processor clock speed.                            |
| Minimum Clock Speed          | Displays the minimum processor clock speed.                            |
| Current Clock Speed          | Displays the current processor clock speed.                            |

**Table 4. System setup options—System information menu (continued)**

| <b>Overview</b>               |   |
|-------------------------------|---|
| Core Count                    | Displays the number of cores on the processor.                  |
| Processor ID                  | Displays the processor identification code.                     |
| Processor L2 Cache            | Displays the processor L2 Cache size.                           |
| Processor L3 Cache            | Displays the processor L3 Cache size.                           |
| Microcode Version             | Displays the microcode version.                                 |
| Intel Hyper-Threading Capable | Displays whether the processor is Hyper-Threading (HT) capable. |
| 64-Bit Technology             | Displays whether 64-bit technology is used.                     |
| <b>Memory Information</b>     |   |
| Memory Installed              | Displays the total system memory installed.                     |
| Memory Available              | Displays the total system memory available.                     |
| Memory Speed                  | Displays the memory speed.                                      |
| Memory Channel Mode           | Displays single or dual channel mode.                           |
| Memory Technology             | Displays the technology that is used for the memory.            |
| DIMM 1 Size                   | Displays the DIMM 1 memory size.                                |
| DIMM 2 Size                   | Displays the DIMM 2 memory size.                                |
| DIMM 3 Size                   | Displays the DIMM 3 memory size.                                |
| DIMM 4 Size                   | Displays the DIMM 4 memory size.                                |
| DIMM 5 Size                   | Displays the DIMM 5 memory size.                                |
| DIMM 6 Size                   | Displays the DIMM 6 memory size.                                |
| DIMM 7 Size                   | Displays the DIMM 7 memory size.                                |
| DIMM 8 Size                   | Displays the DIMM 8 memory size.                                |
| DIMM 9 Size                   | Displays the DIMM 9 memory size.                                |
| DIMM 10 Size                  | Displays the DIMM 10 memory size.                               |
| DIMM 11 Size                  | Displays the DIMM 11 memory size.                               |
| DIMM 12 Size                  | Displays the DIMM 12 memory size.                               |
| DIMM 13 Size                  | Displays the DIMM 13 memory size.                               |
| DIMM 14 Size                  | Displays the DIMM 14 memory size.                               |
| DIMM 15 Size                  | Displays the DIMM 15 memory size.                               |
| DIMM 16 Size                  | Displays the DIMM 16 memory size.                               |
| <b>Devices Information</b>    |   |
| Native Resolution             | Displays the native resolution of the system.                   |
| Audio Controller              | Displays the audio controller information of the system.        |
| LOM MAC Address               | Displays the LOM MAC address of the system.                     |
| dGPU Video Controller         | Displays the video controller type of the system.               |
| LOM 2 MAC Address             | Displays the LOM 2 MAC address of the system.                   |
| Slot 1                        | Displays the Panel Type of the system.                          |
| Slot 2                        | Displays the PCI slot information of the system.                |
| Slot 3                        | Displays the PCI slot information of the system.                |
| Slot 4                        | Displays the PCI slot information of the system.                |

**Table 4. System setup options—System information menu (continued)**

| Overview |  |
|----------|--|
| Slot 5   | Displays the PCI slot information of the system. |
| Slot 6   | Displays the PCI slot information of the system. |
| Slot 7   | Displays the PCI slot information of the system. |
| Slot 8   | Displays the PCI slot information of the system. |

**Table 5. System setup options—Boot Configuration menu**

| Boot Configuration            |  |
|-------------------------------|--|
| <b>Boot Sequence</b>          |  |
| Boot mode                     | Displays the boot mode.  |
| Boot Sequence                 | Displays the boot sequence.  |
| Secure Digital (SD) Card Boot | Enable or disable the SD card read-only boot.<br>By default, the <b>Secure Digital (SD) Card Boot</b> option is not enabled. |
| <b>Secure Boot</b>            |  |
| Enable Secure Boot            | Enable or disable the secure boot feature.<br>By default, the option is not enabled.   |
| Secure Boot Mode              | Enable or disable to change the secure boot mode options.<br>By default, the <b>Deployed Mode</b> is enabled.                |
| <b>Expert Key Management</b>  |  |
| Enable Custom Mode            | Enable or disable custom mode.<br>By default, the <b>custom mode</b> option is not enabled.                                  |
| Custom Mode Key Management    | Select the custom values for expert key management.  |

**Table 6. System setup options—Integrated Devices menu**

| Integrated Devices                    |   |
|---------------------------------------|---|
| <b>Date/Time</b>                      | Displays the current date in MM/DD/YYYY format and current time in HH:MM:SS AM/PM format.   |
| <b>HDD Fans</b>                       | Enables or disable the HDD fans.  |
| Limit system memory to less than 1 TB | Enable or disable to limit the system memory to slightly under 1 TB even when more than 1 TB of memory is installed on the system.<br>By default, the option is disabled. |
| <b>Audio</b>                          |   |
| Enable audio                          | Enable or disable the microphone and the internal speakers.<br>By default, all the options are enabled.   |
| <b>Serial Port</b>                    |   |
| Serial Port 1 Configuration           | Displays the serial port configuration information of the system.<br>By default, the <b>COM1 : Port is configured at 3F8h with IRQ 4</b> option is enabled.               |
| <b>PCIe Bifurcation</b>               | Enable or disable the configuration settings of the CPU's PCIe port bifurcation feature.<br>By default, the <b>Auto</b> option is enabled.                                |
| <b>PCIe Bus Allocation</b>            | Displays the PCIe bus allocation information of the system.   |

**Table 6. System setup options—Integrated Devices menu (continued)**

|                           |   |
|---------------------------|---|
| <b>Integrated Devices</b> |   |
|                           | By default, the <b>Default</b> option is enabled. |

**Table 7. System setup options—Storage menu**

|                                |  |
|--------------------------------|--|
| <b>Storage</b>                 |  |
| <b>SATA/NVMe Operation</b>     |  |
| SATA/NVMe Operation            | Set the operating mode of the integrated storage device controller.<br>By default, the <b>RAID On</b> option is enabled.   |
| <b>Storage interface</b>       |  |
| Port Enablement                | This page allows you to enable the onboard drives.<br>By default, all the options are enabled.   |
| <b>SMART Reporting</b>         |  |
| Enable SMART Reporting         | Enable or disable Self-Monitoring, Analysis, and Reporting Technology (SMART) during system startup.<br>By default, the <b>Enable SMART Reporting</b> option is not enabled. |
| <b>Drive Information</b>       |  |
| <b>SATA-0</b>                  |  |
| Type                           | Displays the SATA-0 type information of the system.  |
| Device                         | Displays the SATA-0 device information of the system.  |
| <b>SATA-1</b>                  |  |
| Type                           | Displays the SATA-1 type information of the system.  |
| Device                         | Displays the SATA-1 device information of the system.  |
| <b>SATA-2</b>                  |  |
| Type                           | Displays the SATA-2 type information of the system.  |
| Device                         | Displays the SATA-2 device information of the system.  |
| <b>SATA-4</b>                  |  |
| Type                           | Displays the SATA-4 type information of the system.  |
| Device                         | Displays the SATA-4 device information of the system.  |
| <b>SATA-5</b>                  |  |
| Type                           | Displays the SATA-5 type information of the system.  |
| Device                         | Displays the SATA-5 device information of the system.  |
| <b>SATA-6</b>                  |  |
| Type                           | Displays the SATA-6 type information of the system.  |
| Device                         | Displays the SATA-6 device information of the system.  |
| <b>SATA-7</b>                  |  |
| Type                           | Displays the SATA-7 type information of the system.  |
| Device                         | Displays the SATA-7 device information of the system.  |
| <b>Slimline SAS PCIE SSD-0</b> |  |
| Type                           | Displays the slimline SAS PCIE SSD-0 type information of the system.   |
| Device                         | Displays the slimline SAS PCIE SSD-0 device information of the system.   |
| <b>Slimline SAS PCIE SSD-1</b> |  |

**Table 7. System setup options—Storage menu (continued)**

| <b>Storage</b>                          |  |
|---|--|
| Type                                    | Displays the slimline SAS PCIE SSD-1 type information of the system.   |
| Device                                  | Displays the slimline SAS PCIE SSD-1 device information of the system.   |
| <b>Slimline SAS PCIE SSD-2</b>          |  |
| Type                                    | Displays the slimline SAS PCIE SSD-2 type information of the system.   |
| Device                                  | Displays the slimline SAS PCIE SSD-2 device information of the system.   |
| <b>Slimline SAS PCIE SSD-3</b>          |  |
| Type                                    | Displays the slimline SAS PCIE SSD-3 type information of the system.   |
| Device                                  | Displays the slimline SAS PCIE SSD-3 device information of the system.   |
| <b>Slimline SAS PCIE SSD-4</b>          |  |
| Type                                    | Displays the slimline SAS PCIE SSD-4 type information of the system.   |
| Device                                  | Displays the slimline SAS PCIE SSD-4 device information of the system.   |
| <b>Slimline SAS PCIE SSD-5</b>          |  |
| Type                                    | Displays the slimline SAS PCIE SSD-5 type information of the system.   |
| Device                                  | Displays the slimline SAS PCIE SSD-5 device information of the system.   |
| <b>Slimline SAS PCIE SSD-6</b>          |  |
| Type                                    | Displays the slimline SAS PCIE SSD-6 type information of the system.   |
| Device                                  | Displays the slimline SAS PCIE SSD-6 device information of the system.   |
| <b>Slimline SAS PCIE SSD-7</b>          |  |
| Type                                    | Displays the slimline SAS PCIE SSD-7 type information of the system.   |
| Device                                  | Displays the slimline SAS PCIE SSD-7 device information of the system.   |
| <b>Enable MediaCard</b>                 |  |
| Secure Digital (SD) Card                | Enable or disable the SD card.<br>By default, the <b>Secure Digital (SD) Card</b> option is enabled.                                   |
| Secure Digital (SD) Card Read-Only Mode | Enable or disable the SD card read-only mode.<br>By default, the <b>Secure Digital (SD) Card Read-Only Mode</b> option is not enabled. |

**Table 8. System setup options—Display menu**

| <b>Display</b>            |   |
|---------------------------|---|
| <b>Primary Video Slot</b> |   |
| Primary Video Slot        | Enable to determine which video controller becomes the primary display when multiple controllers are available in the system.<br>By default, the <b>Auto</b> option is enabled. |
| <b>Full Screen Logo</b>   |   |
|                           | Enable or disable full screen logo.<br>By default, the option is not enabled.   |

**Table 9. System setup options—Connection menu**

| <b>Connection</b>                       |  |
|---|--|
| <b>Network Controller Configuration</b> |  |
| Integrated NIC 1                        | Enable or disable the on-board LAN controller.<br>By default, the <b>Enabled with PXE</b> option is enabled. |

**Table 9. System setup options—Connection menu (continued)**

| Connection                       |  |
|----------------------------------|--|
| Integrated NIC 2                 | Enable or disable the on-board LAN controller.<br>By default, the <b>Enabled</b> option is enabled.                                      |
| <b>Enable UEFI Network Stack</b> | Enable or disable UEFI Network Stack and controls the on-board LAN Controller.<br>By default, the <b>Auto Enabled</b> option is enabled. |
| <b>HTTP(s) Boot Feature</b>      |  |
| HTTP(s) Boot                     | Enable or disable the HTTPs Boot feature.<br>By default, the option is enabled.  |
| HTTP(s) Boot Modes               | By default, the <b>Auto Mode</b> option is enabled.  |

**Table 10. System setup options—Power menu**

| Power                                |  |
|--------------------------------------|--|
| <b>USB PowerShare</b>                | Enables the system to run on battery during peak power usage hours. Use the table <b>Custom Charge Start</b> and <b>Custom Charge Stop</b> , to prevent AC power usage between certain times of each day.<br>By default, the <b>Adaptive</b> option is enabled.  |
| Enable USB PowerShare                | Enable or disable the USB PowerShare feature.<br>By default, the option is enabled.  |
| Enable Peak Shift                    | By default, the <b>Enable Peak Shift</b> option is disabled.   |
| <b>Thermal Management</b>            | Enables to cool the fan and processor heat management to adjust the system performance, noise, and temperature.<br>By default, the <b>Optimized</b> option is enabled.   |
| <b>Lower PCIe Slot Zone</b>          | Allows you to increase the target fan speed on the Lower PCIe slot zone using this control.  |
| <b>CPU/Memory Zone</b>               | Allows you to increase the target fan speed on the CPU/Memory Zone using this control.   |
| <b>Upper PCIe Slot Zone</b>          | Allows you to increase the target fan speed on the Upper PCIe slot zone using this control.  |
| <b>Storage Zone</b>                  | Allows you to increase the target fan speed on the storage zone using this control.  |
| <b>USB Wake Support</b>              |  |
| Enable USB Wake Support              | When enabled, the USB devices like a mouse or keyboard can be used to wake the system from Standby, Hibernate, and Power Off.<br><b>i</b> <b>NOTE:</b> This feature requires Deep Sleep Control to be disabled.<br><b>i</b> <b>NOTE:</b> This feature is only functional when the AC power adapter is connected. If the AC power adapter is removed before Standby, the BIOS will remove power from all the USB ports to conserve battery power.<br>By default, the <b>Enable USB Wake Support</b> option is disabled. |
| <b>AC Behavior</b>                   | Enables the system to turn on automatically, when AC is inserted.<br>By default, the <b>Power Off</b> option is enabled.   |
| <b>Active State Power Management</b> | Allows you to set the active state power management level.<br>By default, the <b>Auto</b> option is enabled.   |

**Table 10. System setup options—Power menu (continued)**

| Power                               |  |
|-------------------------------------|--|
| <b>Block Sleep</b>                  | Enables to block entering sleep (S3) mode in the operating system.<br>By default, the <b>Block Sleep</b> option is disabled.   |
| <b>Deep Sleep Control</b>           | Deep Sleep Control option is disabled in order to enable the Wake from USB keyboard and mouse feature to work in the shutdown (S5) and Hibernate (S4) states.<br>By default, the option is disabled. |
| <b>Intel Speed Shift Technology</b> | Enable or disable the Intel speed shift technology support.<br>By default, the <b>Intel Speed Shift Technology</b> option is enabled.  |

**Table 11. System setup options—Security menu**

| Security   |  |
|--|--|
| <b>TPM 2.0 Security</b>  |  |
| TPM 2.0 Security On  | Allows you to enable or disable TPM visibility to operating system.<br>By default, the <b>TPM 2.0 Security On</b> option is enabled.   |
| Attestation Enable   | Enables to control whether the Trusted Platform Module (TPM) Endorsement Hierarchy is available to the operating system.<br>By default, the <b>Attestation Enable</b> option is enabled. |
| Key Storage Enable   | Enables to control whether the Trusted Platform Module (TPM) Storage Hierarchy is available to the operating system.<br>By default, the <b>Key Storage Enable</b> option is enabled.     |
| SHA-256  | When enabled, the BIOS and TPM will use the SHA-256 hash algorithm to extend measurements into the TPM PCRs during BIOS boot.<br>By default, the <b>SHA-256</b> option is enabled.       |
| Clear  | Enables to clear the TPM owner information and returns the TPM to the default state.<br>By default, the <b>Clear</b> option is disabled.   |
| PPI Bypass for Clear Commands  | Controls the TPM Physical Presence Interface (PPI).<br>By default, the <b>PPI ByPass for clear Commands</b> option is disabled.  |
| <b>Intel Total Memory Encryption</b>   |  |
| Total Memory Encryption  | Enable or disable to protect memory from physical attacks including freeze spray, probing DDR to read the cycles, and others.<br>By default, the option is disabled.                     |
| <b>SMM Security Mitigation</b>   | Enable or disable additional UEFI SMM Security Mitigation protections.<br>By default, the option is disabled.  |
| <b>Data Wipe on Next Boot</b>  |  |
| Start Data Wipe  | Enable or disable the data wipe on next boot.<br>By default, the <b>Start Data Wipe</b> option is disabled.  |
| Absolute   | Enable or disable or permanently disable the BIOS module interface of the optional Absolute Persistence Module service from Absolute software.<br>By default, the option is enabled.     |
|  <b>WARNING: The 'Permanently Disabled' option can only be selected once. When 'Permanently Disabled' is selected, Absolute</b> |  |

**Table 11. System setup options—Security menu (continued)**

| Security                                     |  |
|--|--|
|  | <p><b>Persistence cannot be re-enabled. No further changes to the Enable/Disable states are allowed.</b></p> <p><b>i</b> <b>NOTE:</b> The Enable/Disable options will be unavailable while Computrace is in the activated state.</p> |
| UEFI Boot Path Security                      | <p>Controls whether the system prompt the user to enter the admin password (if set) when booting to a UEFI boot path device from the F12 boot menu.</p> <p>By default, the <b>Always Except Internal HDD</b> option is enabled.</p>  |
| <b>Authenticated BIOS Interface</b>          |  |
| Enable Authenticated BIOS Interface          | <p>Enable or disable the authenticated BIOS interface.</p> <p>By default, the option is disabled.</p>  |
| <b>Legacy Manageability Interface Access</b> |  |
|  | <p>Allows the platform administrator to control access through the Legacy Manageability Interface Access when ABI is enabled and provisioned.</p> <p>By default, the option is enabled.</p>  |

**Table 12. System setup options—Update, Recovery menu**

| Update, Recovery                       |   |
|--|---|
| <b>UEFI Capsule Firmware Updates</b>   | <p>Enable or disable BIOS updates through UEFI capsule update packages.</p> <p><b>i</b> <b>NOTE:</b> Disabling this option blocks BIOS updates from services such as Microsoft Windows Update and Linux Vendor Firmware Service (LVFS).</p> <p>By default, the option is enabled.</p>   |
| <b>BIOS Recovery from Hard Drive</b>   | <p>Enables the user to recover from certain corrupted BIOS conditions from a recovery file on the user primary hard drive or an external USB key.</p> <p>By default, the option is enabled.</p> <p><b>i</b> <b>NOTE:</b> BIOS Recovery from Hard Drive is not available for self-encrypting drives (SED).</p>   |
| <b>BIOS Downgrade</b>                  |   |
| Allow BIOS Downgrade                   | <p>This field controls the flashing of the system firmware to previous revisions.</p> <p>By default, the option is enabled.</p>   |
| <b>SupportAssist OS Recovery</b>       |   |
|  | <p>Enable or disable the boot flow for SupportAssist OS Recovery tool in the event of certain system errors.</p> <p>By default, the option is enabled.</p>  |
| <b>BIOSConnect</b>                     |   |
|  | <p>Enable or disable cloud Service operating system recovery if the main operating system fails to boot with the number of failures equal to or greater than the value specified by the Auto operating system Recovery Threshold setup option and local Service operating system does not boot or is not installed.</p> <p>By default, the option is enabled.</p> |
| <b>Dell Auto OS Recovery Threshold</b> | <p>Controls the automatic boot flow for SupportAssist System Resolution Console and for Dell operating system Recovery Tool.</p> <p>By default, the threshold value is set to 2.</p>  |

**Table 13. System setup options—System Management menu**

| System Management  |   |
|--------------------|---|
| <b>Service Tag</b> | Displays the Service Tag of the system. |

**Table 13. System setup options—System Management menu (continued)**

| System Management                            |  |
|--|--|
| <b>Asset Tag</b>                             | Create a system Asset Tag.   |
| <b>Wake on LAN/WLAN</b>                      |  |
| Wake on LAN/WLAN                             | Enable or disable the computer to power on by special LAN signals when it receives a wakeup signal from the WLAN.<br><br>By default, the option is disabled.   |
| <b>Auto on Time</b>                          | Enable to set the computer to turn on automatically every day or on a preselected date and time. This option can be configured only if the Auto On Time is set to Everyday, Weekdays, or Selected Days.<br><br>By default, the option is disabled. |
| <b>Intel AMT Capability</b>                  | Enable or disable the Intel AMT capability.<br><br>By default, the <b>Restrict Preboot Access</b> option is enabled.   |
| <b>SERR Messages</b>                         | Enable or disable the SERR message mechanism.<br><br>By default, the option is enabled.  |
| <b>First Power On Date</b>                   |  |
| Set Ownership Date                           | Allows to set the ownership date.<br><br>By default, the option is disabled.   |
| <b>Diagnostics</b>                           |  |
| OS Agent Requests                            | Enable or disable the OS agent requests.<br><br>By default, the option is enabled.   |
| <b>Power-on-Self-Test Automatic Recovery</b> | Enable or disable the Power-on-Self-Test Automatic Recovery option.<br><br>By default, the option is enabled.  |

**Table 14. System setup options—Keyboard menu**

| Keyboard                                  |  |
|---|--|
| <b>Keyboard Errors</b>                    |  |
| Enable Keyboard Error Detection           | Enable or disable the keyboard error detection.<br><br>By default, the option is enabled.  |
| <b>Numlock LED</b>                        | Allows you to enable or disable the Numlock function when the system boots.<br><br>By default, the option <b>Fn Lock Options</b> is enabled. |
| Enable Numlock LED                        | Allows you to enable or disable the Numlock LED.<br><br>By default, the option is enabled.   |
| <b>Device Configuration Hotkey Access</b> | Enable or disable the device configuration hotkey access.<br><br>By default, the option is enabled.  |

**Table 15. System setup options—Pre-boot Behavior menu**

| Pre-boot Behavior            |  |
|------------------------------|--|
| <b>Warning and Errors</b>    | Enable or disable the action to be done when a warning or error is encountered.<br><br>By default, the <b>Prompt on Warnings and Errors</b> option is enabled. |
| <b>Extend BIOS POST Time</b> | Set the BIOS POST load time.<br><br>By default, the <b>0 seconds</b> option is enabled.  |

**Table 16. System setup options—Virtualization menu**

| <b>Virtualization</b>                           |  |
|---|--|
| <b>Intel Virtualization Technology</b>          |  |
| Enable Intel Virtualization Technology (VT)     | When enabled, the system will be able to run a Virtual Machine Monitor (VMM).<br><br>By default, the option is enabled.  |
| <b>VT for Direct I/O</b>                        | When enabled, the system will be able to perform Virtualization Technology for Direct I/O (VT-d).<br><br>By default, the option is enabled.  |
| <b>Intel Trusted Execution Technology (TXT)</b> |  |
| Enable Intel Trusted Execution Technology (TXT) | Specifies whether a measured Virtual Machine Monitor (MVMM) can use the additional hardware capabilities that are provided by Intel Trusted Execution Technology. The following must be enabled in order to enable Intel TXT. <ul style="list-style-type: none"> <li>● Trusted Platform Module (TPM)</li> <li>● Intel Hyper-Threading</li> <li>● All CPU cores (Multi-Core Support)</li> <li>● Intel Virtualization Technology</li> <li>● Intel VT for Direct I/O</li> </ul> By default, the option is disabled. |
| <b>DMA Protection</b>                           |  |
| Enable Pre-Boot DMA Support                     | Enable or disable Pre-Boot DMA support.<br><br>By default, the option is enabled.  |
| Enable OS Kernel DMA Support                    | Enable or disable OS Kernel DMA support.<br><br>By default, the option is enabled.   |
| <b>Intel Speed Select Technology</b>            | Allows you to configure the processor by trading off many, identical, peer cores versus prioritizing a smaller number of high priority cores which get increased based frequency, power, cache, and Intel Turbo speed.<br><br>By default, the <b>Computational</b> option is enabled.  |
| <b>Multi-Core Support</b>                       | Enables to change the number of CPU cores available to the operating system.<br><br>By default, the All Cores options is enabled.  |
| <b>Enable Dell RMT</b>                          | Enable or disable Dell Reliable Memory Technology (RMT) to identify and isolate memory errors in the system RAM.<br><br>By default, the option is enabled.   |
| <b>Clear Dell RMT Log</b>                       | By default, the option is disabled.  |
| <b>Intel SpeedStep</b>                          | Enables the computer to dynamically adjust processor voltage and core frequency, decreasing average power consumption and heat production.<br><br>By default, the option is enabled.   |
| <b>C-States Control</b>                         | Enable or disable additional processor sleep states.<br><br>By default, the option is enabled.   |
| <b>Intel Turbo Boost Technology</b>             | Enable or disable Intel TurboBoost mode of the processor.<br><br>By default, the option is enabled.  |
| <b>Intel Hyper-Threading Technology</b>         | Enable or disable Hyper-Threading in the processor.<br><br>By default, the option is enabled.  |

**Table 16. System setup options—Virtualization menu (continued)**

| Virtualization                                    |   |
|---|---|
| <b>Dynamic Tuning:Machine Learning</b>            | <p>Enable or disable the operating system capability to enhance dynamic power tuning capabilities based on the detected workloads.</p> <p>By default, the option is disabled.</p> |
| <b>Cache Prefetch</b>                             | <p>Enable hardware prefetcher to turn on the MLC streamer prefetcher.</p>   |
| <b>Hardware Prefetcher</b>                        | <p>By default, the option is enabled.</p>   |
| <b>Adjacent Cache Prefetch</b>                    | <p>By default, the option is enabled.</p>   |
| <b>Pcie Link Speed</b>                            | <p>Allows you to select the maximum PCIe link speed attainable by devices within the system.</p> <p>By default, the <b>Auto</b> option is enabled.</p>                            |
| <b>PCIe Resizable Base Address Register (BAR)</b> | <p>Enable or disable the PCIe resizable BAR support.</p> <p>By default, the option is disabled.</p>   |
| <b>RAS Support</b>                                |   |
| Memory RAS  | <p>Enable or disable RAS on memory modules to report errors and help minimize system downtime caused by memory failures.</p> <p>By default, the option is disabled.</p>           |
| PCIE RAS  | <p>Enable or disable RAS on PCIe modules to log errors caused by PCIe failures.</p> <p>By default, the option is disabled.</p>  |
| CPU RAS   | <p>Enable or disable RAS on CPU to log errors caused by CPU failures.</p> <p>By default, the option is disabled.</p>  |

**Table 17. System setup options—Performance menu**

| Performance                             |  |
|---|--|
| <b>Intel Speed Select Technology</b>    | <p>Allows you to configure the processor by trading off many, identical, peer cores versus prioritizing a smaller number of high priority cores which get increased based frequency, power, cache, and Intel Turbo speed.</p> <p>By default, the <b>Computational</b> option is enabled.</p> |
| <b>Multi-Core Support</b>               | <p>Enables to change the number of CPU cores available to the operating system.</p> <p>By default, the All Cores options is enabled.</p>   |
| <b>Enable Dell RMT</b>                  | <p>Enable or disable Dell Reliable Memory Technology (RMT) to identify and isolate memory errors in the system RAM.</p> <p>By default, the option is enabled.</p>  |
| <b>Clear Dell RMT Log</b>               | <p>By default, the option is disabled.</p>   |
| <b>Intel SpeedStep</b>                  | <p>Enables the computer to dynamically adjust processor voltage and core frequency, decreasing average power consumption and heat production.</p> <p>By default, the option is enabled.</p>  |
| <b>C-States Control</b>                 | <p>Enable or disable additional processor sleep states.</p> <p>By default, the option is enabled.</p>  |
| <b>Intel Turbo Boost Technology</b>     | <p>Enable or disable Intel TurboBoost mode of the processor.</p> <p>By default, the option is enabled.</p>   |
| <b>Intel Hyper-Threading Technology</b> | <p>Enable or disable Hyper-Threading in the processor.</p>   |

**Table 17. System setup options—Performance menu (continued)**

| Performance                                       |  |
|---|--|
|   | By default, the option is enabled.   |
| <b>Dynamic Tuning:Machine Learning</b>            | Enable or disable the operating system capability to enhance dynamic power tuning capabilities based on the detected workloads.<br>By default, the option is disabled. |
| <b>Cache Prefetch</b>                             | Enable hardware prefetcher to turn on the MLC streamer prefetcher.   |
| <b>Hardware Prefetcher</b>                        | By default, the option is enabled.   |
| <b>Adjacent Cache Prefetch</b>                    | By default, the option is enabled.   |
| <b>Pcie Link Speed</b>                            | Allows you to select the maximum PCIe link speed attainable by devices within the system.<br>By default, the <b>Auto</b> option is enabled.                            |
| <b>PCIe Resizable Base Address Register (BAR)</b> | Enable or disable the PCIe resizable BAR support.<br>By default, the option is disabled.   |
| <b>RAS Support</b>                                |  |
| Memory RAS  | Enable or disable RAS on memory modules to report errors and help minimize system downtime caused by memory failures.<br>By default, the option is disabled.           |
| PCIE RAS  | Enable or disable RAS on PCIe modules to log errors caused by PCIe failures.<br>By default, the option is disabled.  |
| CPU RAS   | Enable or disable RAS on CPU to log errors caused by CPU failures.<br>By default, the option is disabled.  |

**Table 18. System setup options—System Logs menu**

| System Logs                                   |   |
|---|---|
| <b>BIOS Event Log</b>                         |   |
| Clear Bios Event Log                          | Displays BIOS events.<br>By default, the <b>Keep Log</b> option is enabled. |
| <b>Dell Reliable Memory Technology Events</b> | Displays the Dell Reliable Memory Technology events.                        |

## Updating the BIOS

### Updating the BIOS in Windows

#### About this task

 **CAUTION:** If BitLocker is not suspended before updating the BIOS, the next time you reboot the system it will not recognize the BitLocker key. You will then be prompted to enter the recovery key to progress and the system will ask for this on each reboot. If the recovery key is not known this can result in data loss or an unnecessary operating system re-install. For more information on this subject, search in the Knowledge Base Resource at [www.dell.com/support](http://www.dell.com/support).

## Steps

1. Go to [www.dell.com/support](http://www.dell.com/support).
2. Click **Product support**. In the **Search support** box, enter the Service Tag of your computer, and then click **Search**.  
 **NOTE:** If you do not have the Service Tag, use the SupportAssist feature to automatically identify your computer. You can also use the product ID or manually browse for your computer model.
3. Click **Drivers & Downloads**. Expand **Find drivers**.
4. Select the operating system installed on your computer.
5. In the **Category** drop-down list, select **BIOS**.
6. Select the latest version of BIOS, and click **Download** to download the BIOS file for your computer.
7. After the download is complete, browse the folder where you saved the BIOS update file.
8. Double-click the BIOS update file icon and follow the on-screen instructions.  
For more information, search in the Knowledge Base Resource at [www.dell.com/support](http://www.dell.com/support).

## Updating the BIOS in Linux and Ubuntu

To update the system BIOS on a computer that is installed with Linux or Ubuntu, see the knowledge base article [000131486](https://www.dell.com/support) at [www.dell.com/support](http://www.dell.com/support).

## Updating the BIOS using the USB drive in Windows

### About this task

 **CAUTION:** If BitLocker is not suspended before updating the BIOS, the next time you reboot the system it will not recognize the BitLocker key. You will then be prompted to enter the recovery key to progress and the system will ask for this on each reboot. If the recovery key is not known this can result in data loss or an unnecessary operating system re-install. For more information on this subject, search in the Knowledge Base Resource at [www.dell.com/support](http://www.dell.com/support).

## Steps

1. Follow the procedure from step 1 to step 6 in [Updating the BIOS in Windows](#) to download the latest BIOS setup program file.
2. Create a bootable USB drive. For more information, search in the Knowledge Base Resource at [www.dell.com/support](http://www.dell.com/support).
3. Copy the BIOS setup program file to the bootable USB drive.
4. Connect the bootable USB drive to the computer that needs the BIOS update.
5. Restart the computer and press **F12**.
6. Select the USB drive from the **One Time Boot Menu**.
7. Type the BIOS setup program filename and press **Enter**.  
The **BIOS Update Utility** appears.
8. Follow the on-screen instructions to complete the BIOS update.

## Updating the BIOS from the F12 One-Time boot menu

Update your computer BIOS using the BIOS update.exe file that is copied to a FAT32 USB drive and booting from the F12 One-Time boot menu.

### About this task

 **CAUTION:** If BitLocker is not suspended before updating the BIOS, the next time you reboot the system it will not recognize the BitLocker key. You will then be prompted to enter the recovery key to progress and the system will ask for this on each reboot. If the recovery key is not known this can result in data loss or an unnecessary operating system re-install. For more information on this subject, search in the Knowledge Base Resource at [www.dell.com/support](http://www.dell.com/support).

## BIOS Update

You can run the BIOS update file from Windows using a bootable USB drive or you can also update the BIOS from the F12 One-Time boot menu on the computer.

Most of the Dell computers built after 2012 have this capability, and you can confirm by booting your computer to the F12 One-Time Boot Menu to see if BIOS FLASH UPDATE is listed as a boot option for your computer. If the option is listed, then the BIOS supports this BIOS update option.

 **NOTE:** Only computers with BIOS Flash Update option in the F12 One-Time boot menu can use this function.

### Updating from the One-Time boot menu

To update your BIOS from the F12 One-Time boot menu, you need the following:

- USB drive formatted to the FAT32 file system (key does not have to be bootable)
- BIOS executable file that you downloaded from the Dell Support website and copied to the root of the USB drive
- AC power adapter that is connected to the computer
- Functional computer battery to flash the BIOS

Perform the following steps to perform the BIOS update flash process from the F12 menu:

 **CAUTION:** Do not turn off the computer during the BIOS update process. The computer may not boot if you turn off your computer.

### Steps

1. From a turn off state, insert the USB drive where you copied the flash into a USB port of the computer.
2. Turn on the computer and press F12 to access the One-Time Boot Menu, select BIOS Update using the mouse or arrow keys then press Enter.  
The flash BIOS menu is displayed.
3. Click **Flash from file**.
4. Select external USB device.
5. Select the file and double-click the flash target file, and then click **Submit**.
6. Click **Update BIOS**. The computer restarts to flash the BIOS.
7. The computer will restart after the BIOS update is completed.

## System and setup password

Table 19. System and setup password

| Password type   | Description  |
|-----------------|--|
| System password | Password that you must enter to log in to your system.   |
| Setup password  | Password that you must enter to access and make changes to the BIOS settings of your computer. |

You can create a system password and a setup password to secure your computer.

 **CAUTION:** The password features provide a basic level of security for the data on your computer.

 **CAUTION:** Anyone can access the data that is stored on your computer if it is not locked and left unattended.

 **NOTE:** System and setup password feature is disabled.

## Assigning a system setup password

### Prerequisites

You can assign a new **System or Admin Password** only when the status is in **Not Set**.

### About this task

To enter the system setup, press F12 immediately after a power-on or reboot.

### Steps

1. In the **System BIOS** or **System Setup** screen, select **Security** and press Enter.  
The **Security** screen is displayed.
2. Select **System/Admin Password** and create a password in the **Enter the new password** field.  
Use the following guidelines to assign the system password:
  - A password can have up to 32 characters.
  - At least one special character: ! " # \$ % & ' ( ) \* + , - . / : ; < = > ? @ [ \ ] ^ \_ ` { | }
  - Numbers 0 through 9.
  - Upper case letters from A to Z.
  - Lower case letters from a to z.
3. Type the system password that you entered earlier in the **Confirm new password** field and click **OK**.
4. Press Esc and save the changes as prompted by the pop-up message.
5. Press Y to save the changes.  
The computer restarts.

## Deleting or changing an existing system setup password

### Prerequisites

Ensure that the **Password Status** is Unlocked (in the System Setup) before attempting to delete or change the existing System and/or Setup password. You cannot delete or change an existing System or Setup password, if the **Password Status** is Locked.

### About this task

To enter the System Setup, press F12 immediately after a power-on or reboot.

### Steps

1. In the **System BIOS** or **System Setup** screen, select **System Security** and press Enter.  
The **System Security** screen is displayed.
2. In the **System Security** screen, verify that **Password Status** is **Unlocked**.
3. Select **System Password**, update, or delete the existing system password, and press Enter or Tab.
4. Select **Setup Password**, update, or delete the existing setup password, and press Enter or Tab.  
 **NOTE:** If you change the System and/or Setup password, reenter the new password when prompted. If you delete the System and/or Setup password, confirm the deletion when prompted.
5. Press Esc and a message prompts you to save the changes.
6. Press Y to save the changes and exit from System Setup.  
The computer restarts.

## Clearing BIOS (System Setup) and System passwords

### About this task

To clear the system or BIOS passwords, contact Dell technical support as described at [www.dell.com/contactdell](http://www.dell.com/contactdell).

-  **NOTE:** For information on how to reset Windows or application passwords, refer to the documentation accompanying Windows or your application.

# Troubleshooting

## Dell SupportAssist Pre-boot System Performance Check diagnostics

### About this task

SupportAssist diagnostics (also known as system diagnostics) performs a complete check of your hardware. The Dell SupportAssist Pre-boot System Performance Check diagnostics is embedded with the BIOS and is launched by the BIOS internally. The embedded system diagnostics provides a set of options for particular devices or device groups allowing you to:

- Run tests automatically or in an interactive mode
- Repeat tests
- Display or save test results
- Run thorough tests to introduce additional test options to provide extra information about the failed device(s)
- View status messages that inform you if tests are completed successfully
- View error messages that inform you of problems encountered during testing

**NOTE:** Some tests for specific devices require user interaction. Always ensure that you are present at the computer terminal when the diagnostic tests are performed.

For more information, see <https://www.dell.com/support/kbdoc/000180971>.

## Running the SupportAssist Pre-Boot System Performance Check

### Steps

1. Turn on your computer.
2. As the computer boots, press the F12 key as the Dell logo appears.
3. On the boot menu screen, select the **Diagnostics** option.
4. Click the arrow at the bottom left corner.  
Diagnostics front page is displayed.
5. Click the arrow in the lower-right corner to go to the page listing.  
The items detected are listed.
6. To run a diagnostic test on a specific device, press Esc and click **Yes** to stop the diagnostic test.
7. Select the device from the left pane and click **Run Tests**.
8. If there are any issues, error codes are displayed.  
Note the error code and validation number and contact Dell.

## Power-Supply Unit Built-in Self-Test

Built-in Self-Test (BIST) helps determine if the power-supply unit is working. To run self-test diagnostics on the power-supply unit of a desktop or all-in-one computer, search in the Knowledge Base Resource at [www.dell.com/support](http://www.dell.com/support).

## System-diagnostic lights

This section lists the system-diagnostic lights of your computer.

### Power-supply diagnostics light

Indicates the status of the power-supply in either of the two sates:

- Off: No Power
- On: Power is supplied.

### Power button light

**Table 20. Power button LED status**

| Power button LED state | System state   | Description                         |
|------------------------|--|-------------------------------------|
| Off                    | <ul style="list-style-type: none"> <li>• S4</li> <li>• S5</li> </ul> | There is in Hibernate or Off state. |
| Solid White            | S0   | Working state                       |
| Solid Amber            |  | Various sleep states or No POST     |
| Blinking Amber/White   |  | Failure to POST                     |

This platform relies on the Power button LED light blinking in an amber/white pattern to determine a failure as listed in the following table:

**NOTE:**

The blinking patterns consists of two numbers (representing First Group: Amber blinks, Second Group: White blinks).

- **First Group:** The Power button LED light blinks Amber, 1 to 9 times followed by a short pause with LED off for a couple of seconds.
- **Second Group:** The Power button LED light then blinks White, 1 to 9 times, followed by a longer pause before the next cycle starts again after a short interval.

**Example:** No Memory detected (2,3). Power button LED blinks 2-times in Amber followed by a pause, and then blinks 3-times in White. The Power button LED will pause for few seconds before the next cycle repeats itself again.

**Table 21. System-diagnostic lights**

| Blinking pattern |       | Problem description  | Suggested resolution   |
|------------------|-------|--|--|
| Amber            | White |  |  |
| 1                | 1     | TPM detection failure  | Replace the system board.  |
| 1                | 2     | Unrecoverable SPI Flash Failure                              | Replace the system board.  |
| 1                | 5     | EC unable to program i-Fuse                                  | Replace the system board.  |
| 1                | 6     | Generic catch-all for ungraceful EC code flow errors         | Disconnect all power source (AC, battery, coin cell) and drain flea power by pressing and holding down power button for 3~5 seconds.                                 |
| 2                | 1     | CPU failure  | <ul style="list-style-type: none"> <li>• Run the Dell Support Assist/Dell Diagnostics tool.</li> <li>• If problem persists, replace the system board.</li> </ul>     |
| 2                | 2     | System board failure (included BIOS corruption or ROM error) | <ul style="list-style-type: none"> <li>• Flash latest BIOS version</li> <li>• If problem persists, replace the system board.</li> </ul>                              |
| 2                | 3     | No memory/RAM detected                                       | <ul style="list-style-type: none"> <li>• Confirm that the memory module is installed properly.</li> <li>• If problem persists, replace the memory module.</li> </ul> |

**Table 21. System-diagnostic lights (continued)**

| Blinking pattern |       | Problem description                             | Suggested resolution  |
|------------------|-------|---|---|
| Amber            | White |   |   |
| 2                | 4     | Memory/RAM failure                              | <ul style="list-style-type: none"> <li>Reset and swap memory modules among the slots.</li> <li>If problem persists, replace the memory module.</li> </ul>   |
| 2                | 5     | Invalid memory installed                        | <ul style="list-style-type: none"> <li>Reset and swap memory modules among the slots.</li> <li>If problem persists, replace the memory module.</li> </ul>   |
| 2                | 6     | System board/Chipset Error                      | Replace the system board.   |
| 3                | 1     | CMOS battery failure                            | <ul style="list-style-type: none"> <li>Reset the main battery connection.</li> <li>If problem persists, replace the main battery.</li> </ul>  |
| 3                | 2     | PCI or Video card/chip failure                  | Replace the system board.   |
| 3                | 3     | BIOS Recovery image not found                   | <ul style="list-style-type: none"> <li>Flash latest BIOS version</li> <li>If problem persists, replace the system board.</li> </ul>   |
| 3                | 4     | BIOS Recovery image found but invalid           | <ul style="list-style-type: none"> <li>Flash latest BIOS version</li> <li>If problem persists, replace the system board.</li> </ul>   |
| 3                | 5     | Power rail failure                              | Replace the system board.   |
| 3                | 6     | Flash corruption detected by SBIOS.             | <ul style="list-style-type: none"> <li>Press power button for over 25 seconds to do RTC reset. If problem persists, replace the system board.</li> <li>Disconnect all power source (AC, battery, coin cell) and drain flea power by pressing and holding down power button 3~5 seconds to ensure all power are drained.</li> <li>Run "BIOS recovery from USB", and the instructions are in the website <a href="#">Dell support</a>.</li> <li>If problem persists, replace the system board.</li> </ul> |
| 3                | 7     | Timeout waiting on ME to reply to HECI message. | Replace the system board.   |

## Recovering the operating system

When your computer is unable to boot to the operating system even after repeated attempts, it automatically starts Dell SupportAssist OS Recovery.

Dell SupportAssist OS Recovery is a standalone tool that is preinstalled in all Dell computers installed with Windows operating system. It consists of tools to diagnose and troubleshoot issues that may occur before your computer boots to the operating system. It enables you to diagnose hardware issues, repair your computer, back up your files, or restore your computer to its factory state.

You can also download it from the Dell Support website to troubleshoot and fix your computer when it fails to boot into their primary operating system due to software or hardware failures.

For more information about the Dell SupportAssist OS Recovery, see *Dell SupportAssist OS Recovery User's Guide* at [www.dell.com/serviceabilitytools](http://www.dell.com/serviceabilitytools). Click **SupportAssist** and then, click **SupportAssist OS Recovery**.

## Real Time Clock—RTC reset

The Real Time Clock (RTC) reset function allows you or the service technician to recover the recently launched model Dell Latitude and Precision systems from **No POST/No Boot/No Power** situations. You can initiate the RTC reset on the system from a power-off state only if it is connected to AC power. Press and hold the power button for 25 seconds. The system RTC reset occurs after you release the power button.

**NOTE:** If AC power is disconnected from the system during the process or the power button is held longer than 40 seconds, the RTC reset process gets aborted.

The RTC reset will reset the BIOS to Defaults, un-provision Intel vPro and reset the system date and time. The following items are unaffected by the RTC reset:

- Service Tag
- Asset Tag
- Ownership Tag
- Admin Password
- System Password
- HDD Password
- Key Databases
- System Logs

**NOTE:** The IT administrator's vPro account and password on the system will be un-provisioned. The system needs to go through the setup and configuration process again to reconnect it to the vPro server.

The below items may or may not reset based on your custom BIOS setting selections:

- Boot List
- Enable Legacy Option ROMs
- Secure Boot Enable
- Allow BIOS Downgrade

## Backup media and recovery options

It is recommended to create a recovery drive to troubleshoot and fix problems that may occur with Windows. Dell proposes multiple options for recovering Windows operating system on your Dell PC. For more information, see [Dell Windows Backup Media and Recovery Options](#).

## Wi-Fi power cycle

### About this task

If your computer is unable to access the Internet due to Wi-Fi connectivity issues a Wi-Fi power cycle procedure may be performed. The following procedure provides the instructions on how to conduct a Wi-Fi power cycle:

**NOTE:** Some ISPs (Internet Service Providers) provide a modem/router combo device.

### Steps

1. Turn off your computer.

2. Turn off the modem.
3. Turn off the wireless router.
4. Wait for 30 seconds.
5. Turn on the wireless router.
6. Turn on the modem.
7. Turn on your computer.

# Getting help and contacting Dell

## Self-help resources

You can get information and help on Dell products and services using these self-help resources:

**Table 22. Self-help resources**

| Self-help resources   | Resource location  |
|---|--|
| Information about Dell products and services  | <a href="http://www.dell.com">www.dell.com</a>   |
| Tips  |   |
| Contact Support   | In Windows search, type <code>Contact Support</code> , and press Enter.  |
| Online help for operating system  | <a href="http://www.dell.com/support/windows">www.dell.com/support/windows</a><br><a href="http://www.dell.com/support/linux">www.dell.com/support/linux</a>   |
| Access top solutions, diagnostics, drivers and downloads, and learn more about your computer through videos, manuals and documents. | Your Dell computer is uniquely identified by a Service Tag or Express Service Code. To view relevant support resources for your Dell computer, enter the Service Tag or Express Service Code at <a href="http://www.dell.com/support">www.dell.com/support</a> .<br><br>For more information on how to find the Service Tag for your computer, see <a href="#">Locate the Service Tag on your computer</a> . |
| Dell knowledge base articles for a variety of computer concerns   | <ol style="list-style-type: none"> <li>1. Go to <a href="http://www.dell.com/support">www.dell.com/support</a>.</li> <li>2. On the menu bar at the top of the Support page, select <b>Support &gt; Knowledge Base</b>.</li> <li>3. In the Search field on the Knowledge Base page, type the keyword, topic, or model number, and then click or tap the search icon to view the related articles.</li> </ol>  |

## Contacting Dell

To contact Dell for sales, technical support, or customer service issues, see [www.dell.com/contactdell](http://www.dell.com/contactdell).

 **NOTE:** Availability varies by country/region and product, and some services may not be available in your country/region.

 **NOTE:** If you do not have an active Internet connection, you can find contact information about your purchase invoice, packing slip, bill, or Dell product catalog.